

Coolmay

L02-EIP Module User Manual

Version 20.92

October 22, 2020

Copyright © 2020

Shenzhen Coolmay Technology Co., Ltd. reserves all rights

Statement

Copyright Notice

Copyright ©2020

Shenzhen Coolmay Technology Co., Ltd. reserves all rights.

Without the written permission of the company, any unit or individual shall not extract or copy part or all of the content of this document without authorization, and shall not spread it in any form.

Other registered trademarks appearing in this document are owned by their respective owners.

Due to product version upgrades or other reasons, the content of this document will be updated from time to time. Unless otherwise agreed, this document is for reference only. All statements, information and suggestions in this document do not constitute any express or implied guarantee.

Notice

This document describes the use of the L02-EIP module in detail. It is for personnel with certain engineering experience.

Shenzhen Coolmay Technology Co., Ltd. is not responsible for any consequences arising from the use of this information.

Before attempting to use the equipment, please read carefully the relevant precautions of the equipment, and be sure to follow the installation and commissioning safety precautions and operating procedures.

Catalog

1. PRODUCT DESCRIPTION.....	1
1.1. Product Structure.....	1
1.1.1. System indicator definition.....	2
1.1.2. Communication bus interface.....	2
1.2. System structure.....	3
1.3. Electromagnetic compatibility.....	3
1.4. Environmental conditions for transportation, storage and operation.....	5
2. PRODUCT MANUAL.....	6
2.1. Overall description.....	6
2.1.1. Technology standard.....	6
2.2. Dial switch to set IP address.....	7
3. USER GUIDES.....	9
3.1. L02 PLC and L02-EIP for EtherNet/IP communication.....	9
3.1.1. Host mapping address.....	9
3.1.2. Ethernet/IP host program example.....	10
3.2. KV-7500 PLC and L02-EIP for EtherNet/IP communication.....	14
3.2.1. EtherNet / IP setting.....	14
3.2.2. Import the EDS file into the project.....	15
3.2.3. Add another module in the above manner.....	18
3.2.4. Write ladder diagram test program for debugging.....	19
3.3. FP7 PLC and L02-EIP for EtherNet/IP communication.....	20
3.3.1. Configure IP.....	20
3.3.2. Ethernet/IP setting.....	21
3.3.3. Add EDS equipment to the project.....	23
3.4. NX1P2 PLC and L02-EIP for EtherNet/IP communication.....	25
3.4.1. Configure IP.....	25
3.4.2. EtherNet/IP connection setting.....	27
3.4.3. Add target device.....	30
3.4.4. Register variable.....	31

1. Product Description

The communication interface and I/O expansion interface of the L02-EIP modules are designed as a highly integrated single module, with compact structure, stable performance, and super high cost performance. At present, L02 series modules have been widely used in various industrial automation occasions. Because of their high product stability, strong anti-interference ability and excellent performance, they have been highly appreciated by users.

1.1. Product Structure

This section will outline the product structure of the L02-EIP module.

The product structure of the L02-EIP module is as follows:

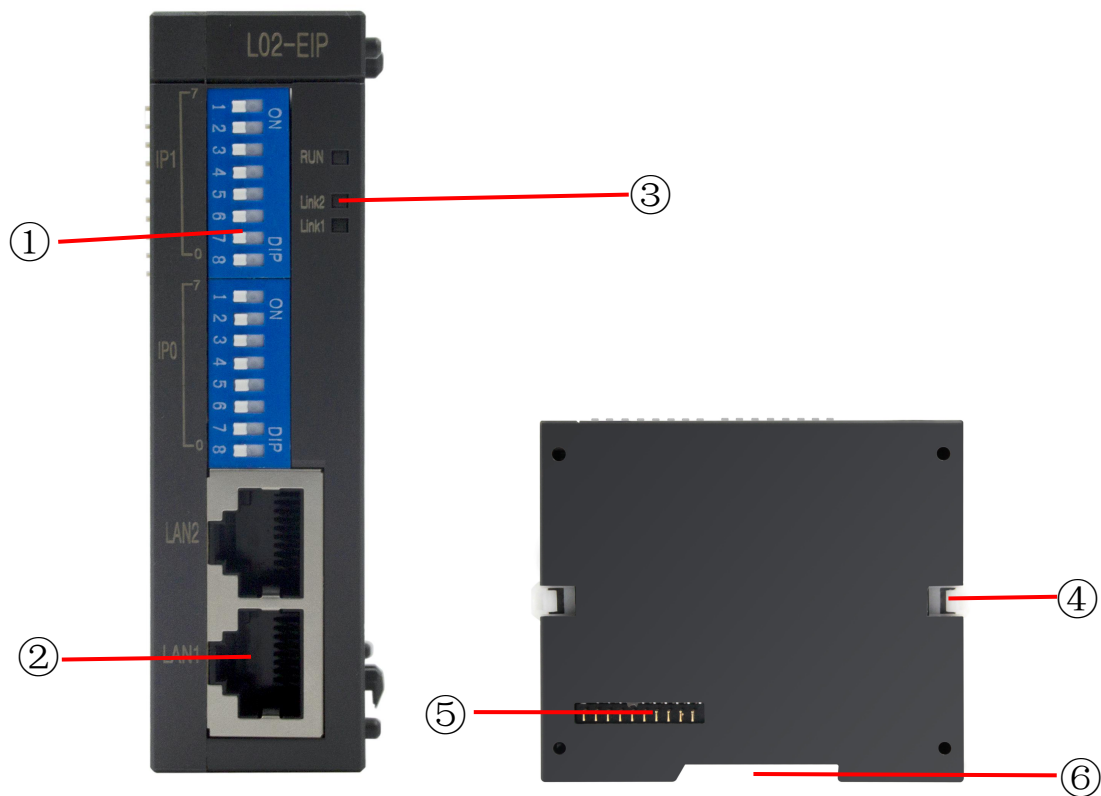

- ① IP1, IP0 setting switch
- ② Network interface*2
- ③ System indicator light

- ④ Fixed buckle
- ⑤ Extension port
- ⑥ 35mm rail installation

The outline dimensions of L02 series modules are as follows:

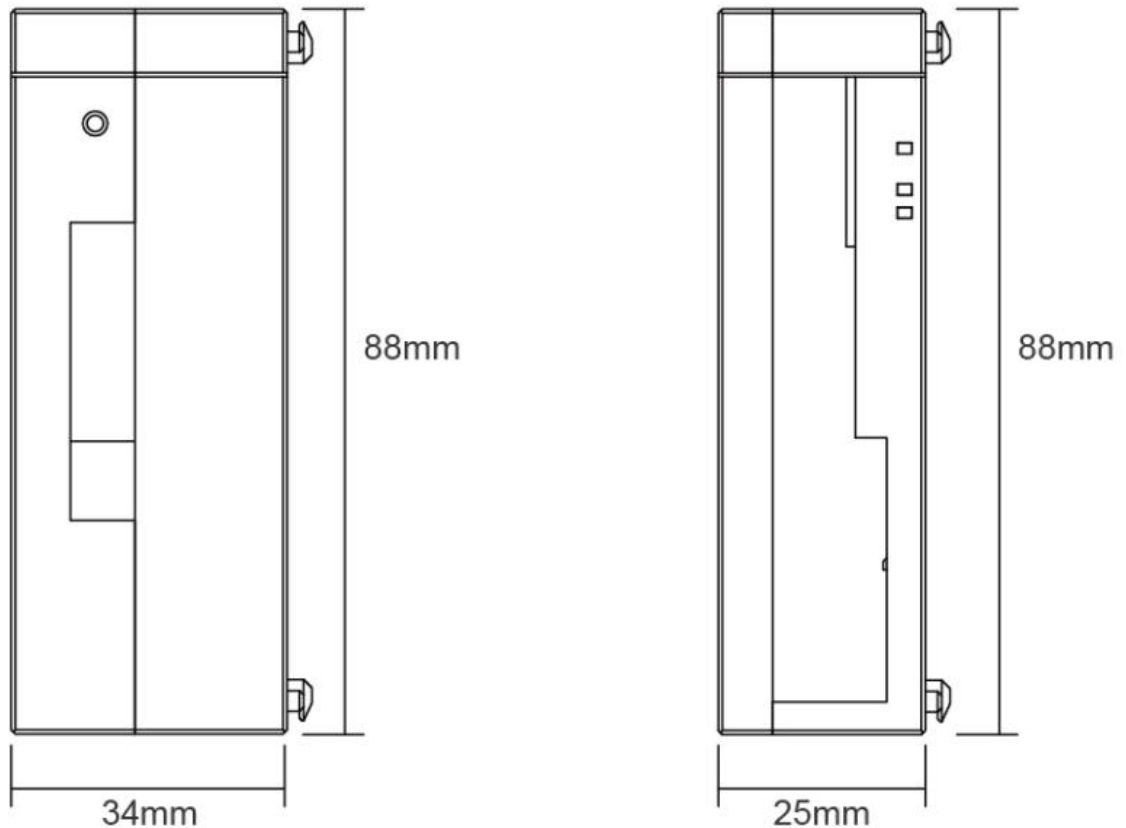

1.1.1. System indicator definition

	Explanation	Colour
RUN	Running indicator light, lights up when the system is running normally	Green
Link1	Running indicator, always on when the system is powered on; flashes when there is data exchange	Green
Link2		

1.1.2. Communication bus interface

The definition of RJ45 communication interface is as follows:

L02-EIP	Signal description	Explanation
1	TD+	Send signal +
2	TD-	Send signal -
3	CT	Center tap

4	NC	Keep
5	CT	Center tap
6	RD+	Receive signal +
7	RD-	Receive signal -
8	GND	Ground

1.2. System structure

The typical application architecture of L02-EIP module is shown in the figure below:

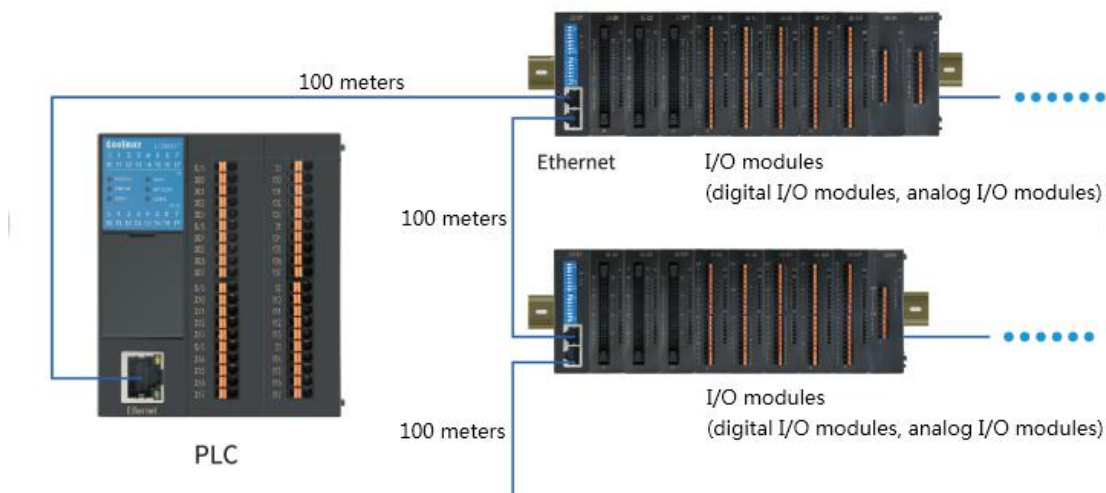

The communication bus protocol adopts the standard EtherNet/IP communication bus, which can easily realize barrier-free connection with EtherNet/IP PLC or industrial computer. The communication interface mode is 2 RJ45 100M Ethernet interfaces, which realize the port switching function internally, and multiple slave stations can be easily cascaded without adding a switch.

1.3. Electromagnetic compatibility

The following table shows the test standards during the L02-EIP module test process.

EMC test	
Surge immunity test IEC 61000-4-5	Power cord: 2KV, 5KHZ (asymmetric)
Pulse group anti-jamming test IEC 61000-4-4	Power cord: 2KV, 5KHz Signal line: 2KV, 5KHz (I/O coupling clamp) 1KV, 5Hz (communication coupling clamp)
Electrostatic immunity test IEC 61000-4-2	Contact discharge: ±4KV Air discharge: ±8KV
Radio frequency electromagnetic field radiation IEC 61000-4-3	80MHz~1GHz, 10V/m, 80%AM (1KHz) 1.4GHz~2GHz, 3V/m, 80%AM (1KHz) 2GHz~2.7GHz, 1V/m, 80%AM (1KHz)
RF field induced conducted interference IEC 61000-4-6	0.15MHz~80MHz,10V/m,80%AM (1KHz)
Short-term interruption and voltage change of DC power input port IEC 61000-4-29	Short interruption: 10ms Voltage change: 80%~120%, 100ms
Environmental test	
High temperature operation IEC 60068-2 Low temperature operation IEC 60068-2	60°C 24 hours -10°C 24 hours
Constant heat and humidity test GB/T 2423.3	Temperature 40°C, humidity 95% 24 hours
High temperature switch test	55°C, 500 times
High temperature storage IEC 60068-2 Low temperature storage IEC 60068-2	70°C 72 hours -10°C 72 hours
Sinusoidal vibration test GB/T 2423.10	10-150Hz, 5 sweeps
Random vibration test GB/T 2423.11	5-200Hz
Impact test GB/T 4857.5	Half sine pulse, duration 11ms, 3 times

1.4. Environmental conditions for transportation, storage and operation

Environmental conditions-transportation and storage	
Temperature	-40°C~70°C
Atmospheric pressure	1080hPa~660hPa (corresponding height is -1000m~+3500m)
Relative humidity	10%~95%, non-condensing
Fall	1m, 10 times, transport package
Environmental conditions-work	
Temperature	Horizontal installation: 0°C~60°C Vertical installation: 0°C~40°C
Atmospheric pressure	1080hPa~795hPa (corresponding height is -1000m~+2000m)
Relative humidity	10%~95%, non-condensing
Harsh environment	Low salt fog, humidity, dust mist and other environments SO ₂ <0.5ppm, relative humidity<60%, non-condensing H ₂ S<0.1ppm, relative humidity<60%, non-condensing

2. Product manual

This chapter mainly introduces the electrical block diagram of L02-EIP module products, the performance parameters of various models, and wiring instructions.

2.1. Overall description

- ◆ The module communication interface supports the EtherNet/IP bus protocol, conforms to the IEC61158 standard and GB/T25105 standard, and can realize the seamless connection of the mainstream EtherNet/IP master station
- ◆ Integrated dual-port switching function, convenient to achieve linear topology
- ◆ Use dial switch to set the IP address, 192.168.IP1.IP0, simple and convenient
- ◆ Use standard DIN35 rail installation

2.1.1. Technology standard

Communication bus	
Bus protocol	EtherNet/IP
Connection method	2*RJ45
Communication rate	100Mb/s
Communication distance	100m (distance from station to station)
Power supply parameter	
Rated input voltage	DC 24V
Effective power supply range	DC 18...36V
Electrical isolation	AC 500V
Status, alarm, diagnosis	
Power status display	Green RUN LED light
Network port indication (flashing when there is data exchange)	The green link1 LED light corresponds to LAN1 The green link2 LED light corresponds to LAN2

2.2. Dial switch to set IP address

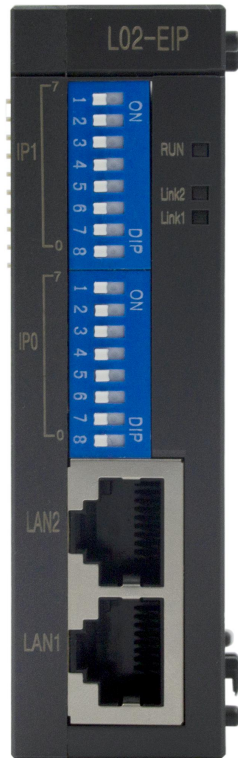

Dial switch	IP1, IP0							
Serial number	1	2	3	4	5	6	7	8
Corresponding bit	Bit7	Bit6	Bit5	Bit4	Bit3	Bit2	Bit1	Bit0

IP address is 192.168.IP1.IP0

IP1 and IP0 are respectively set by the 8-bit (one byte, according to the binary method) dial switch in the figure

For example, set IP 192.168.1.120:

The Dial switch 8 (bit0) of IP1 in the figure is turned ON, and the rest are in the initial position.

In the figure, the Dial switches 5 (bit3), 4 (bit4), 3 (bit5), and 2 (bit6) of IP0 are turned ON, and the rest are in the initial position.

HEX	78
DEC	120
OCT	170
BIN	0111 1000

3. User guides

The L02-EIP module can be connected to different types of EtherNet/IP master stations, and its configuration method and the software used are different. Note that L02-EIP needs to be used with L02 series I/O modules. As an EtherNet/IP slave station, it can expand DI/O up to 512 points and AI/O 50 points. The schematic diagram of the combination (L02-60P power supply+L02-EIP+I/O module) is as follows:



This chapter will introduce the use of L02-EIP module on the four PLCs of Coolmay L02, KEYENCE KV-7500, Panasonic FP7 and Omron NX1P2.

3.1. L02 PLC and L02-EIP for EtherNet/IP communication

In this example, CoolmayL02 is used as the main controller, and the connected module is L02-EIP. The specific operation steps are as follows.

In actual applications, please connect the hardware cables in advance.

3.1.1. Host mapping address

When CoolmayL02 is used as an Ethernet/IP host, it supports up to 4 slaves; The L02 master will automatically map the data of the slave to the corresponding internal address. The mapping relationship is as follows:

Number of slaves D8325	Slave IP	Number of digital input bytes	Host corresponding address 200 pcs	Number of analog input words	50 host corresponding addresses	Connection state
Slave 1	R23830 R23831	R23834	M5000- M5199	R23835	R23100- R23149	R23820
Slave 2	R23840 R23841	R23844	M5200- M5399	R23845	R23150- R23199	R23821
Slave 3	R23850 R23851	R23854	M5400- M5599	R23855	R23200- R23249	R23822
Slave 4	R23860 R23861	R23864	M5600- M5799	R23865	R23250- R23299	R23823
Number of slaves D8325	Slave IP	Number of digital out put bytes	200 host corresponding addresses	Number of analog output words	50 host corresponding addresses	Connection state
Slave 1	R23830 R23831	R23836	M6000- M6199	R23837	R23300- R23349	R23820
Slave 2	R23840 R23841	R23846	M6200- M6399	R23847	R23350- R23399	R23821
Slave 3	R23850 R23851	R23856	M6400- M6599	R23857	R23400- R23449	R23822
Slave 4	R23860 R23861	R23866	M6600- M6799	R23867	R23450- R23599	R23823

3.1.2. Ethernet/IP host program example

As the master, the program settings are as follows, the slave only needs to set the IP.



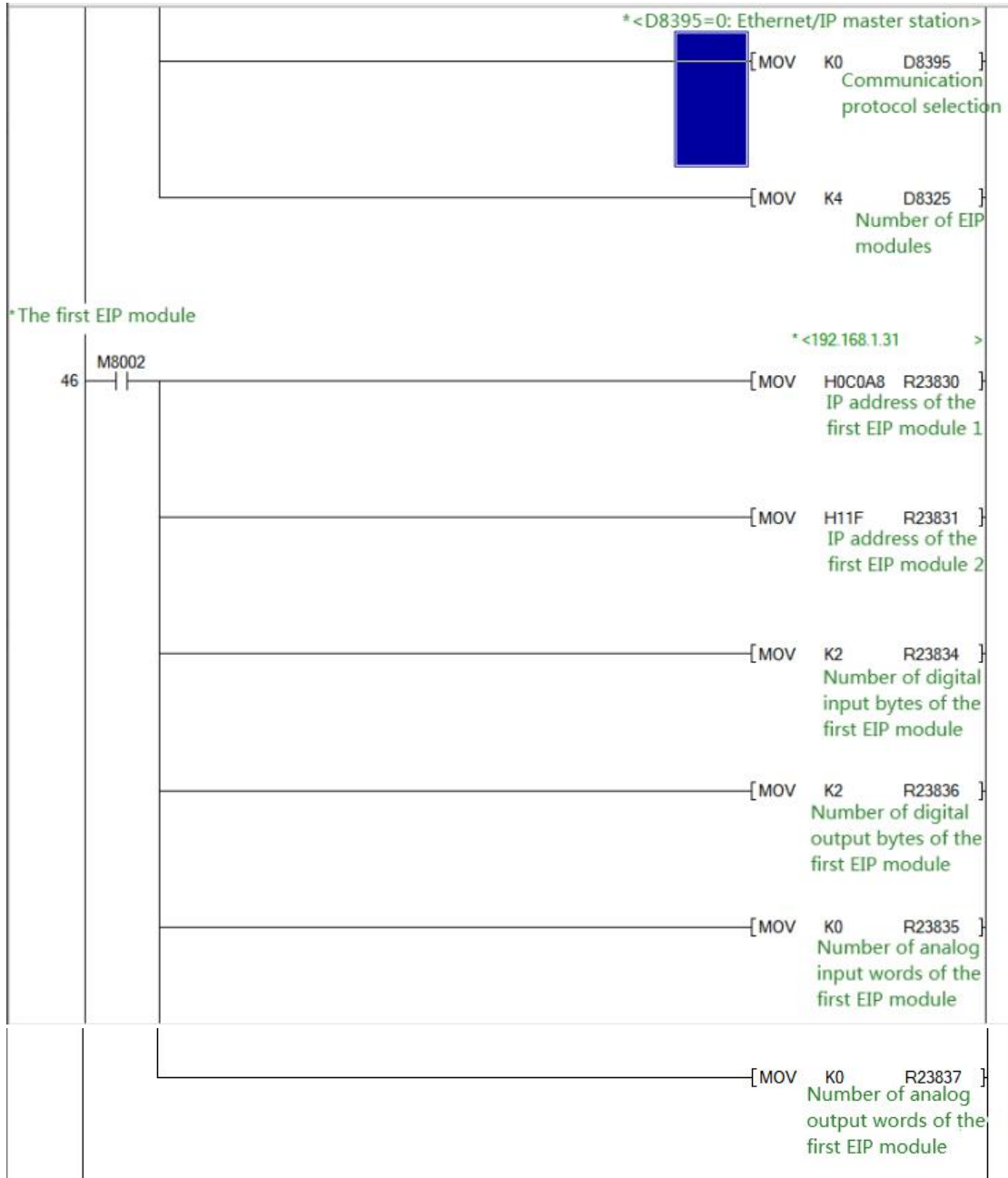

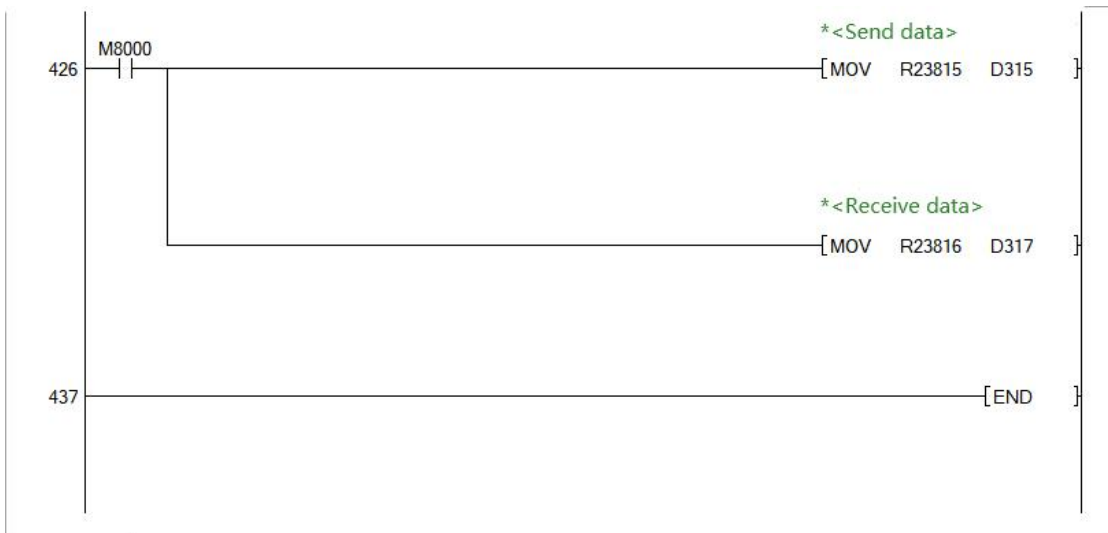
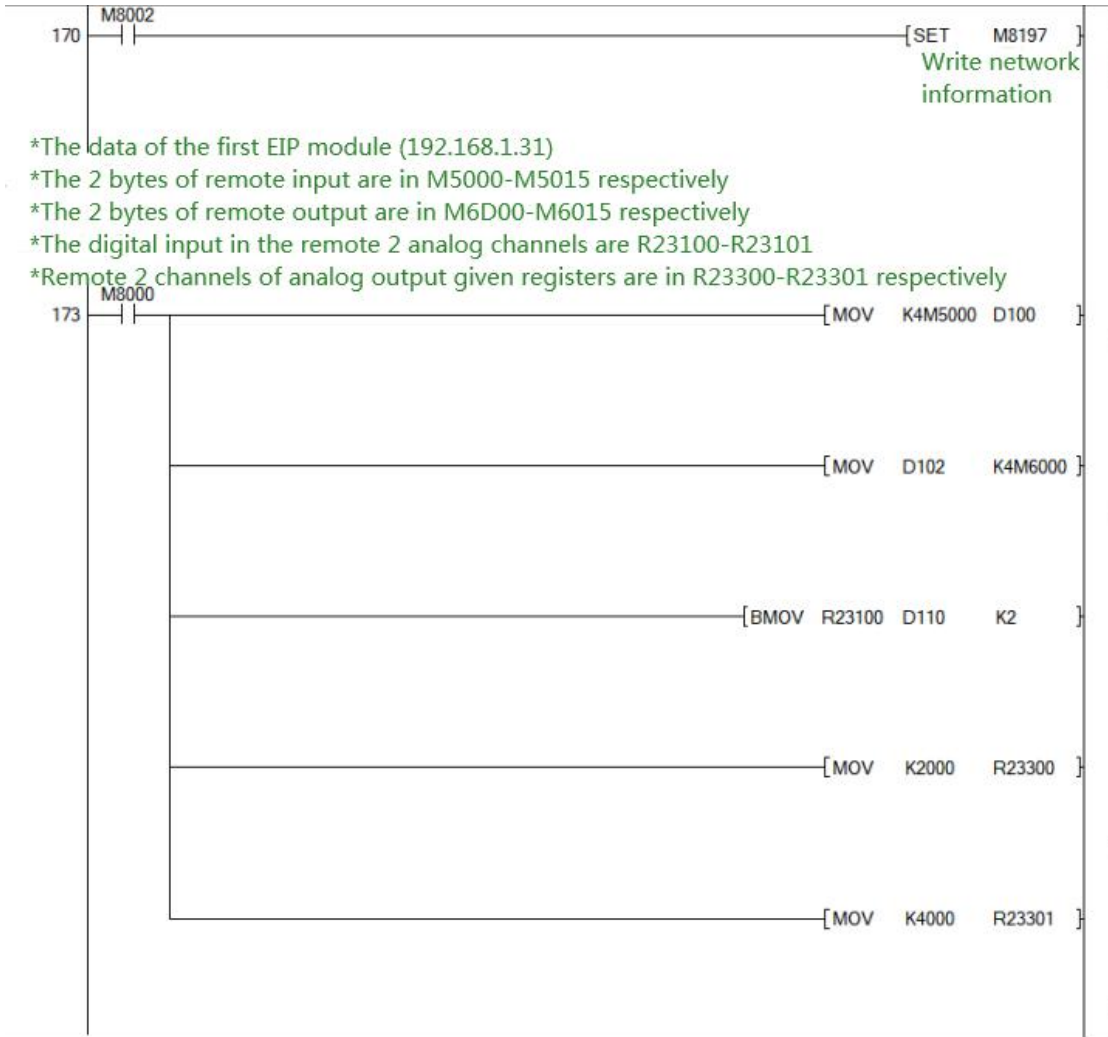

3.2. KV-7500 PLC and L02-EIP for EtherNet/IP communication

In this example, KV-7500 is used as the main control, and the connected module is L02-EIP. The specific operation steps are as follows.

In actual applications, please connect the hardware cables in advance.

3.2.1. EtherNet / IP setting

(1) Open Tools>Built-in Ethernet Setting>EtherNet/IP Setting

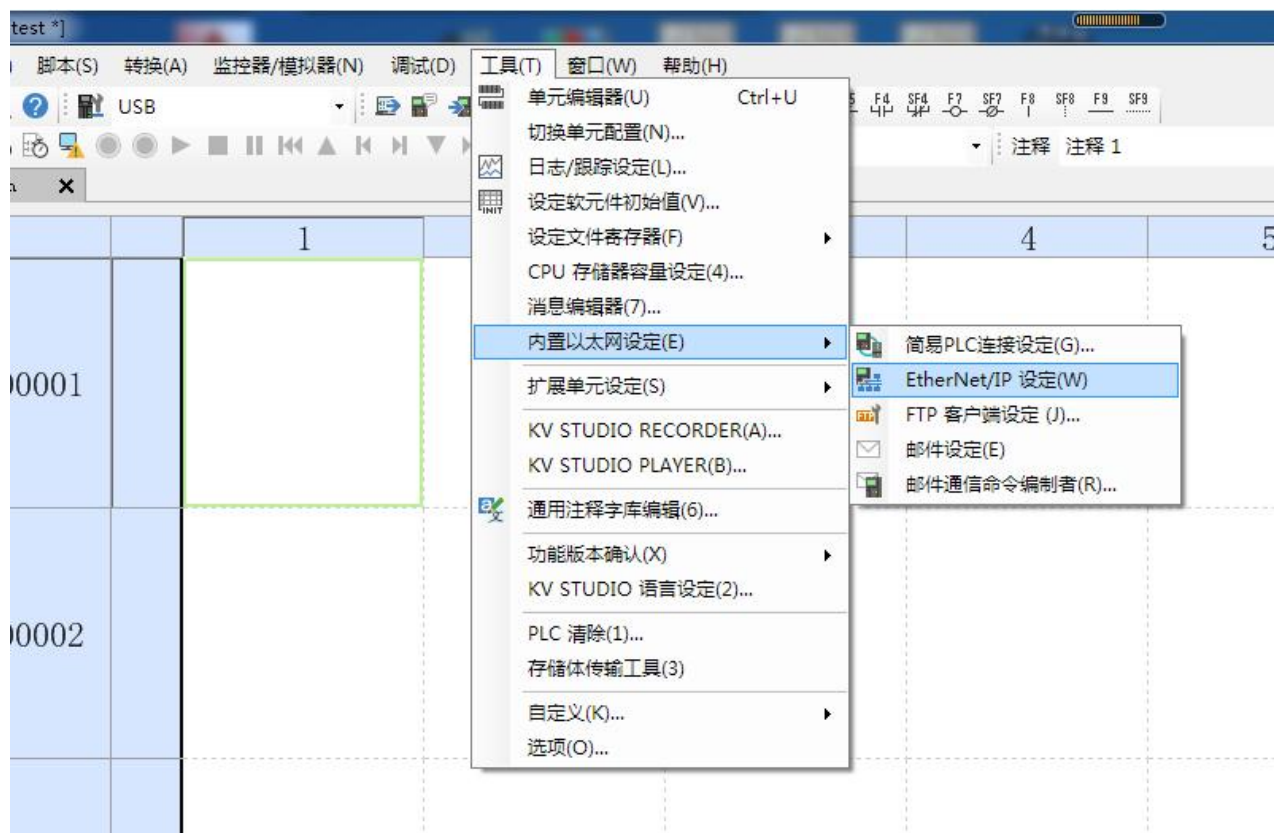

(2) Configure local IP

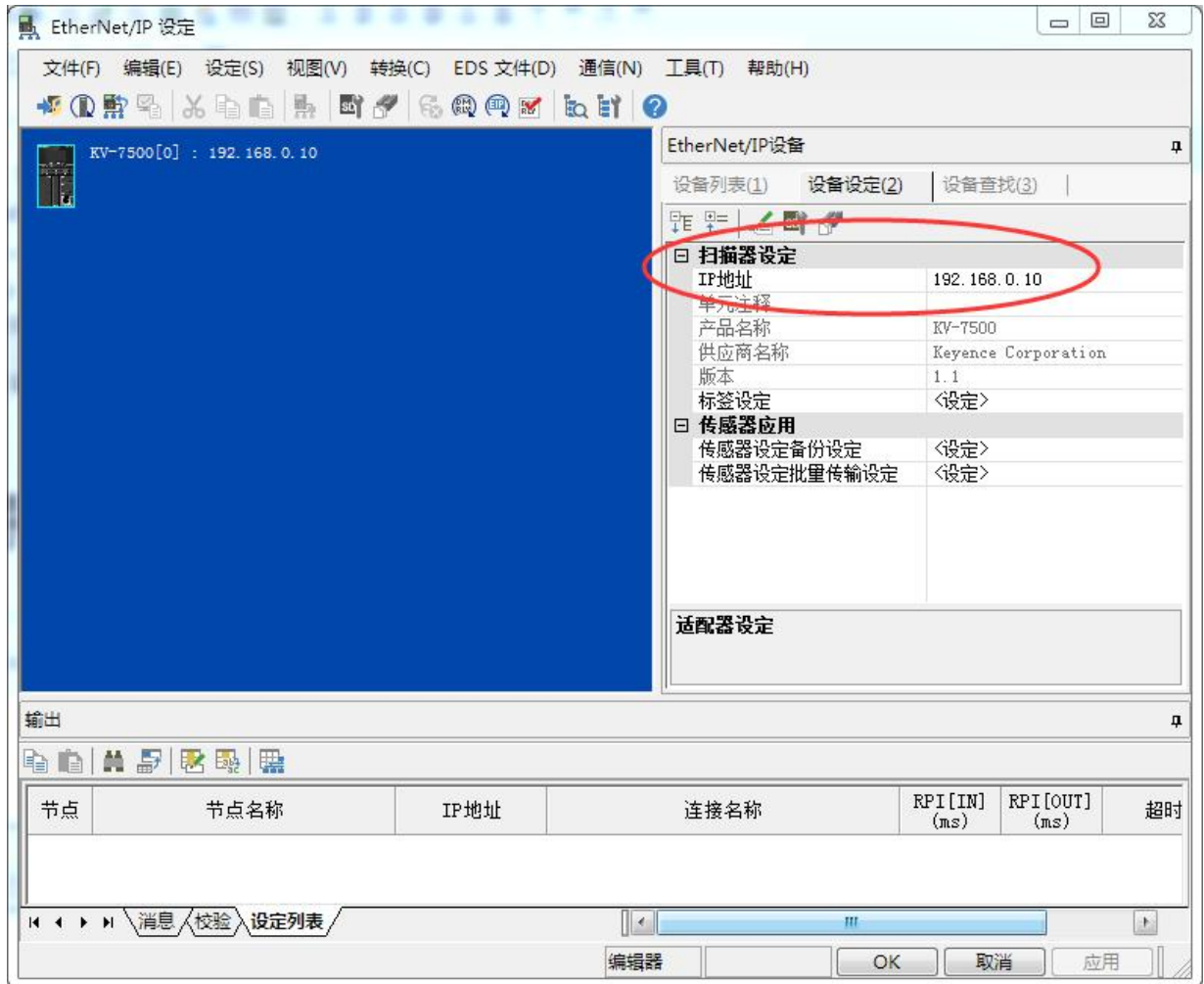

3.2.2. Import the EDS file into the project

(1) EDS file>Login>Select the EDS file of ethip-v1.5-weidmueller-ur20-fbc-EIP

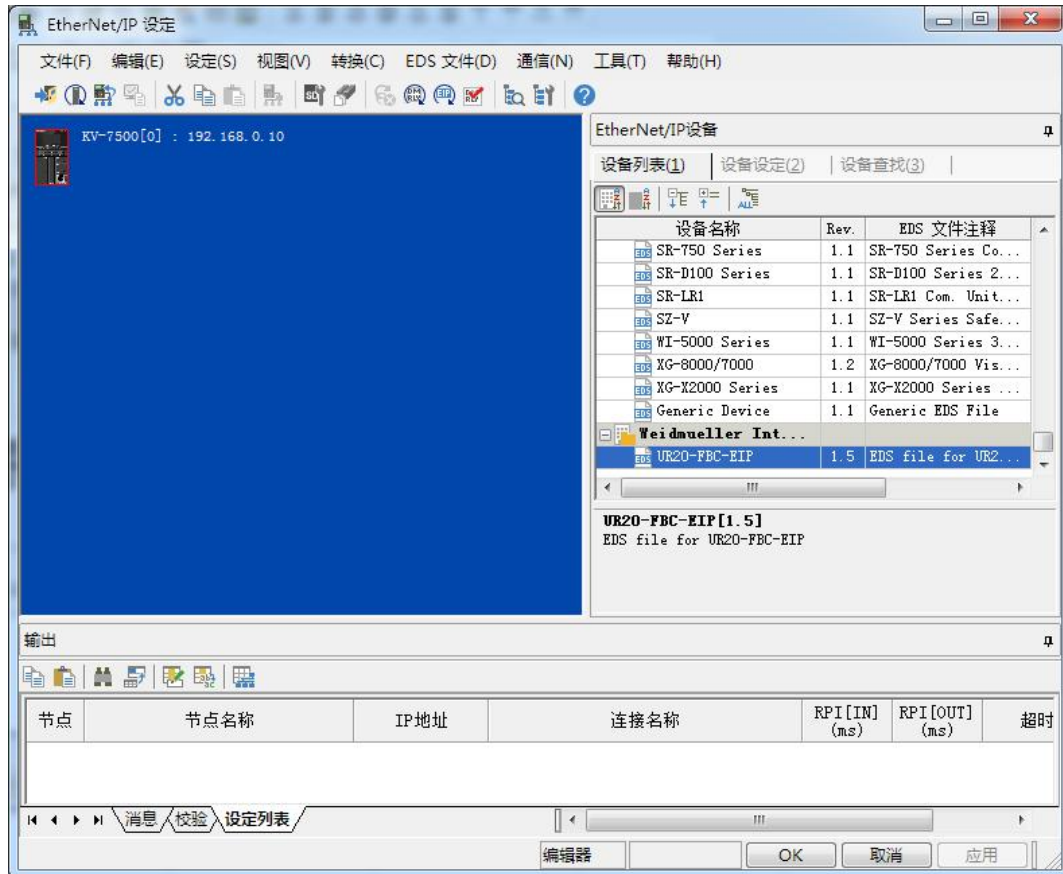

(2) Double-click UR20-FBC-EIP to add a device, set the node address and IP

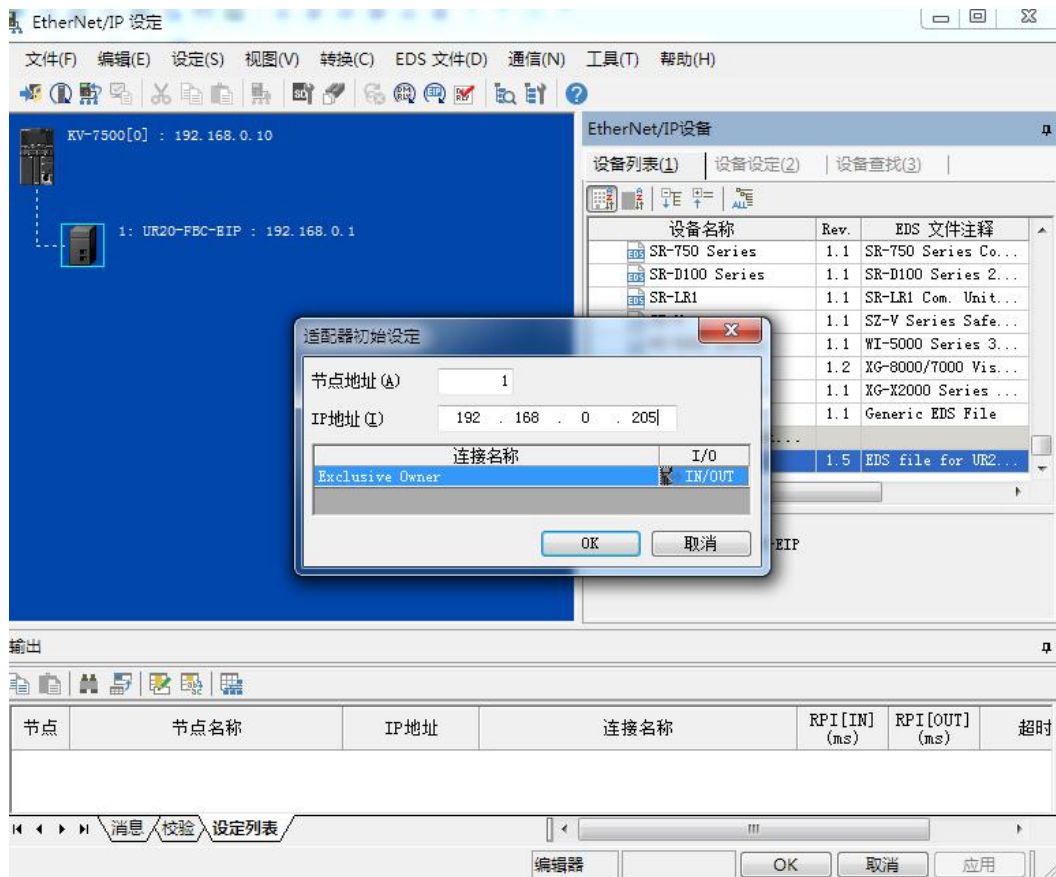

(3) Assign input and output registers.

Click <Edit> under UR20-FBC-EIP, configure the registers corresponding to IN and OUT, which can be assigned automatically or manually.

In this example: IN is automatically assigned as W00

OUT is automatically assigned as W02.

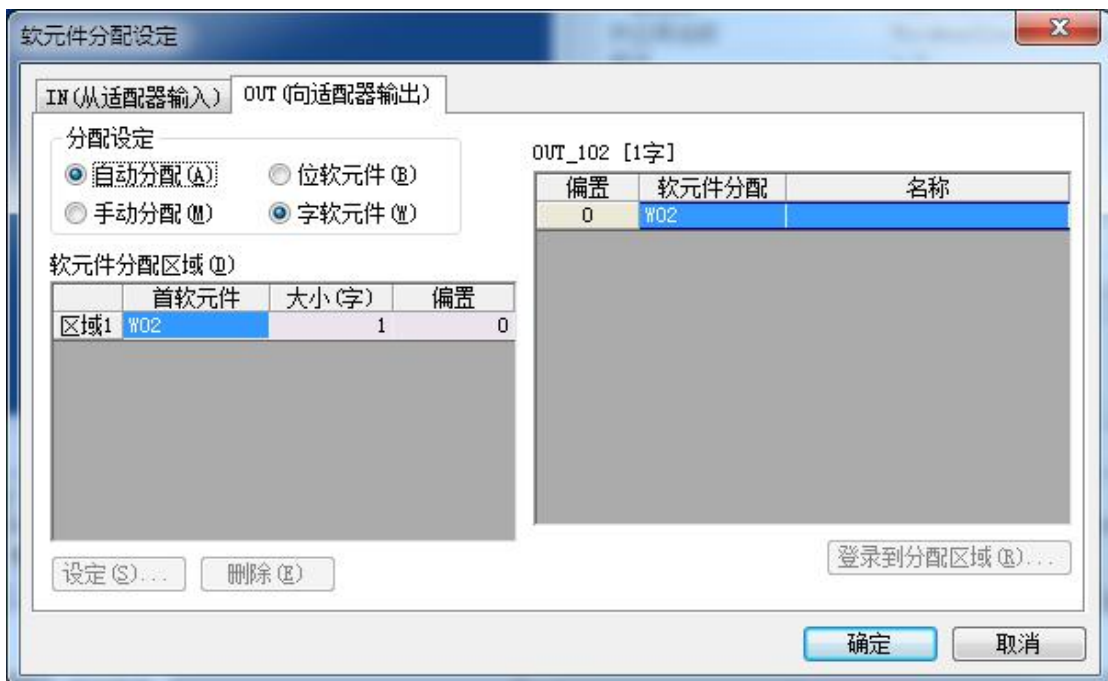
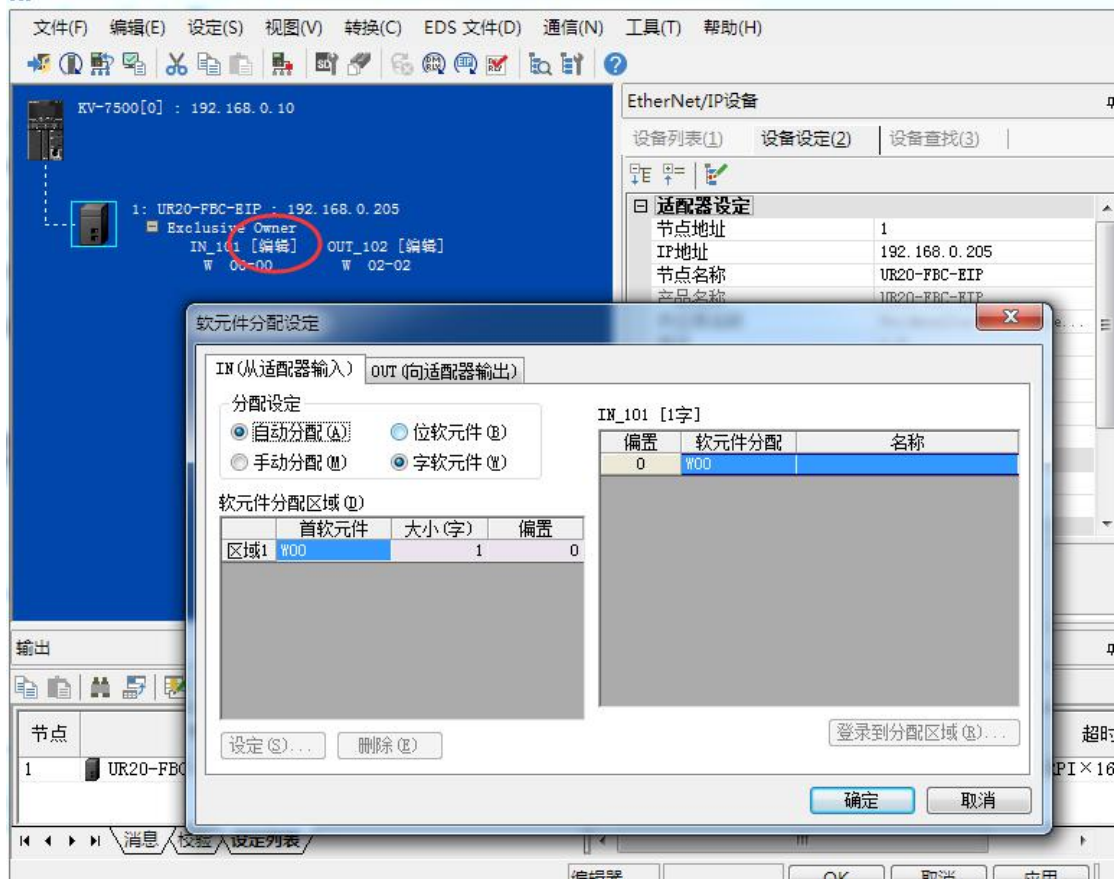

3.2.3. Add another module in the above manner

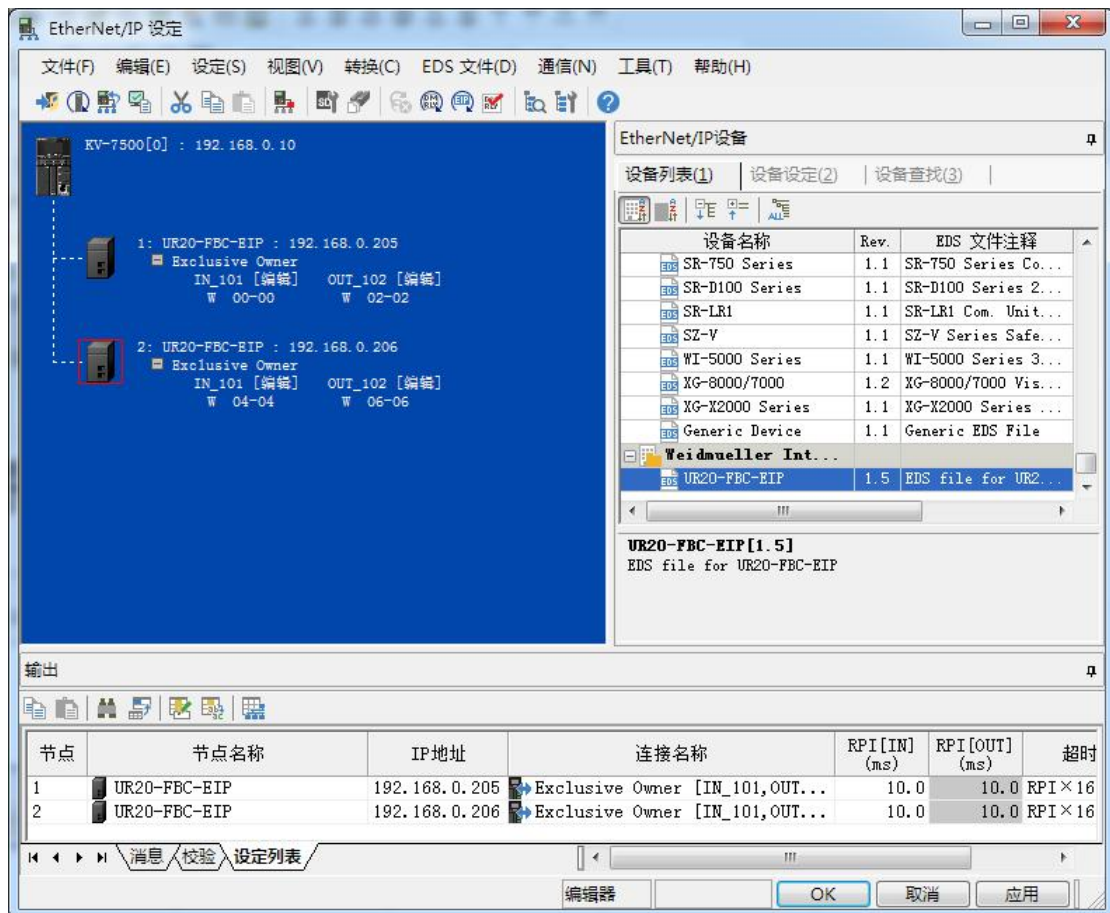

3.2.4. Write ladder diagram test program for debugging

- (1) Write the test program ladder, W02 and W06 by the 100MS plus 1, then the installation program and configuration write PLC:

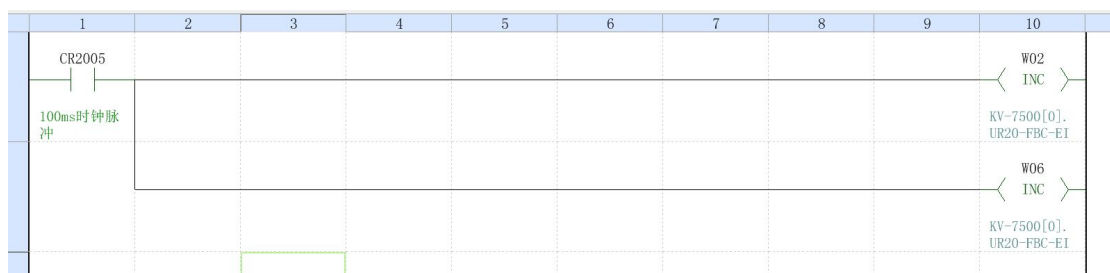

- (2) Run KV-7500 PLC, network cable connected to the module, the module can be seen that the output will flash rapidly.

3.3. FP7 PLC and L02-EIP for EtherNet/IP communication

In this example, FP7 PLC is used as the main control, and the connected module is L02-EIP. The specific operation steps are as follows.

In actual applications, please connect the hardware cables in advance.

3.3.1. Configure IP

(1) Open FP7 configuration> built-in ET-LAN setting

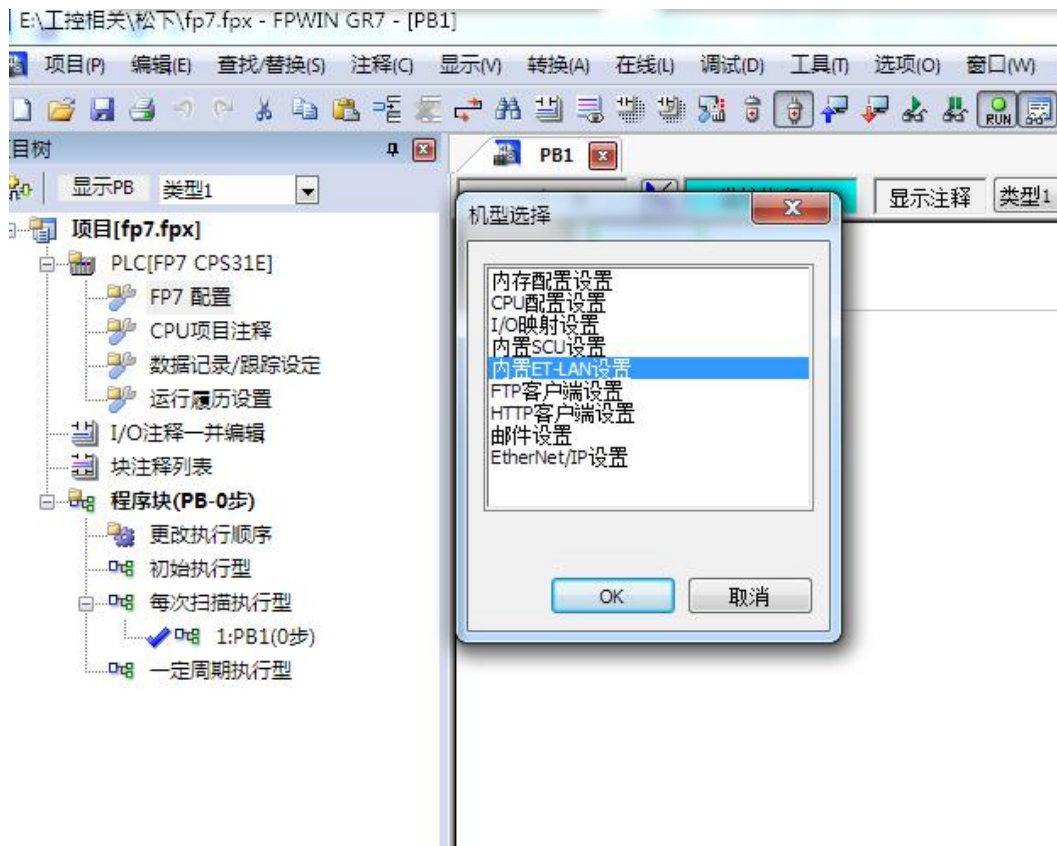

(2) Configure local IP

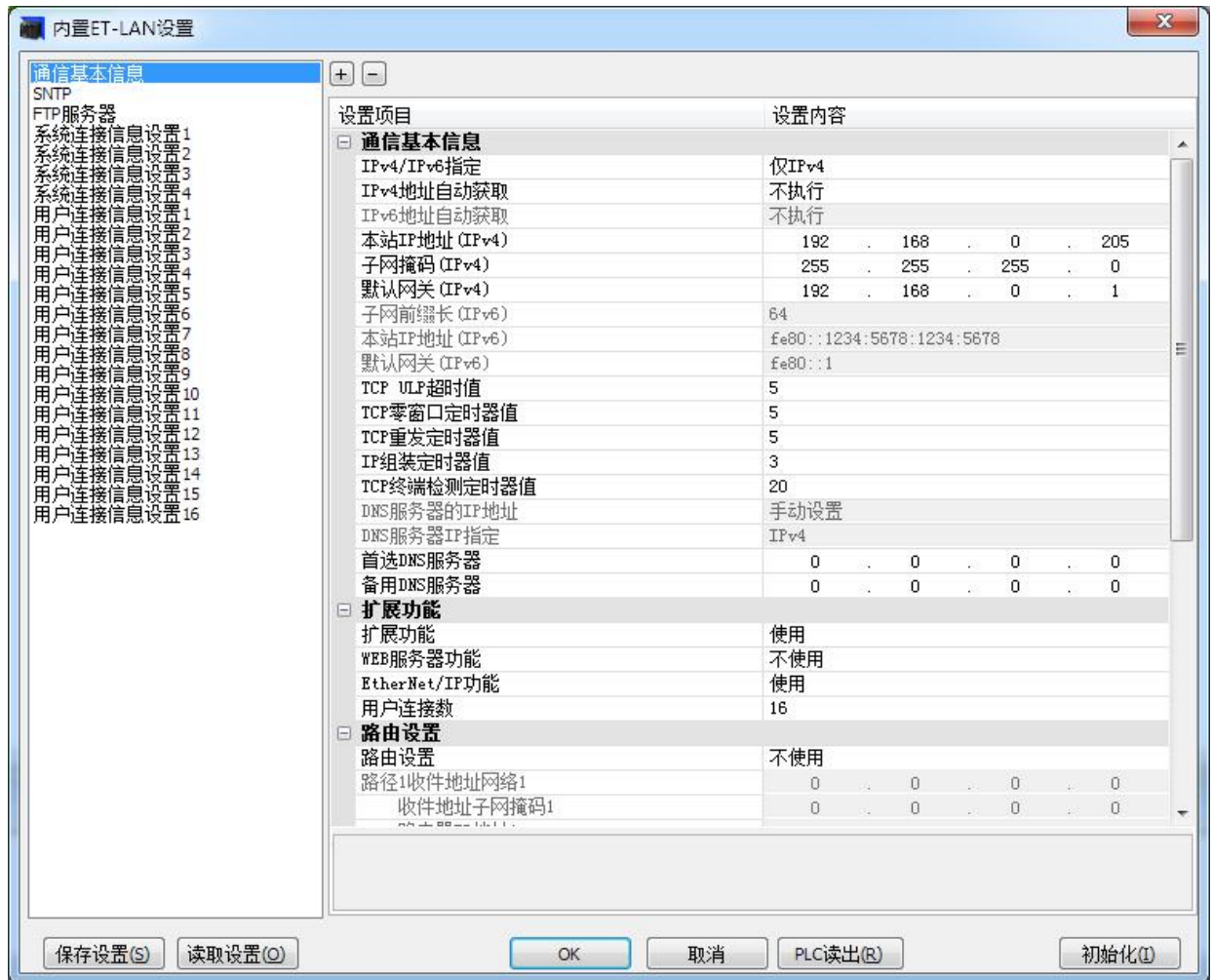

3.3.2. Ethernet/IP setting

(1) Open FP7 configuration>Ethernet/IP setting

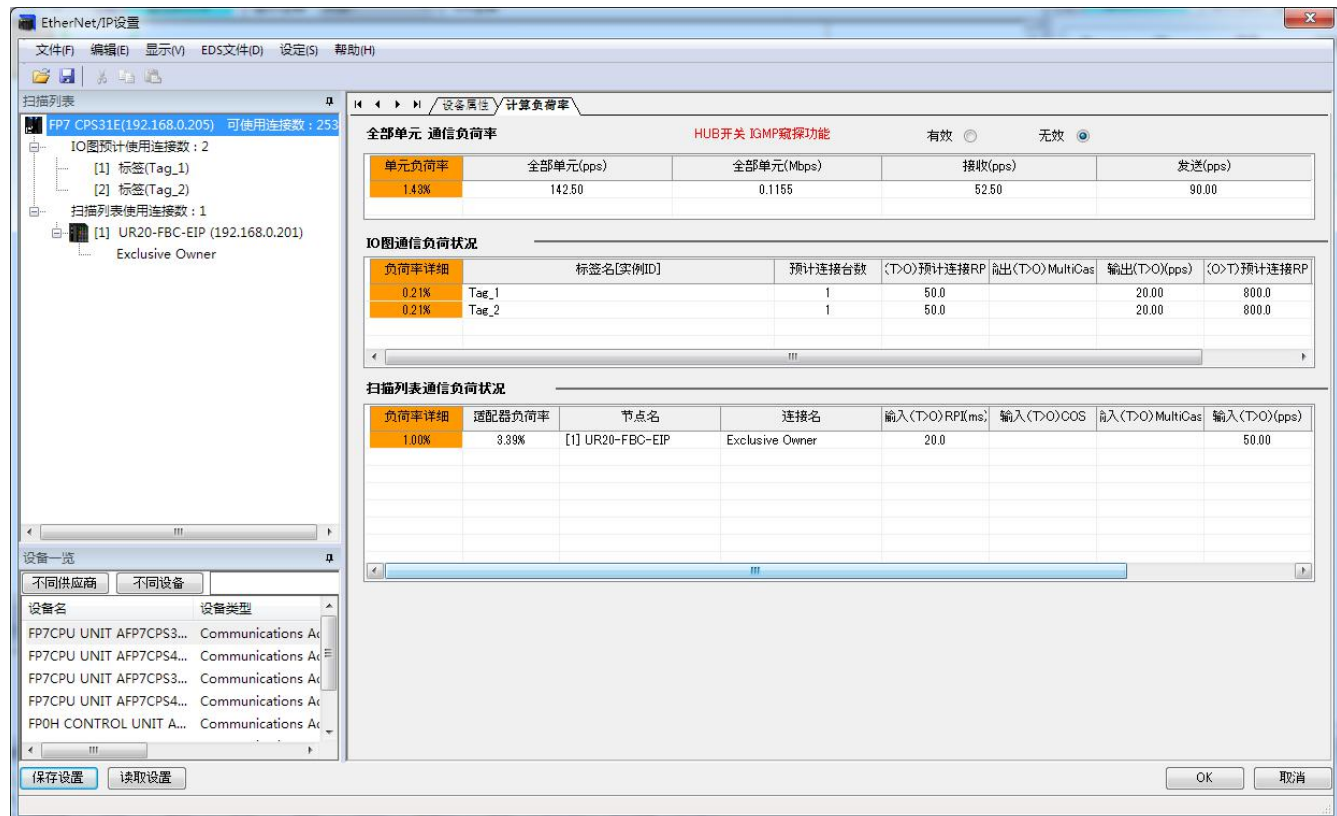
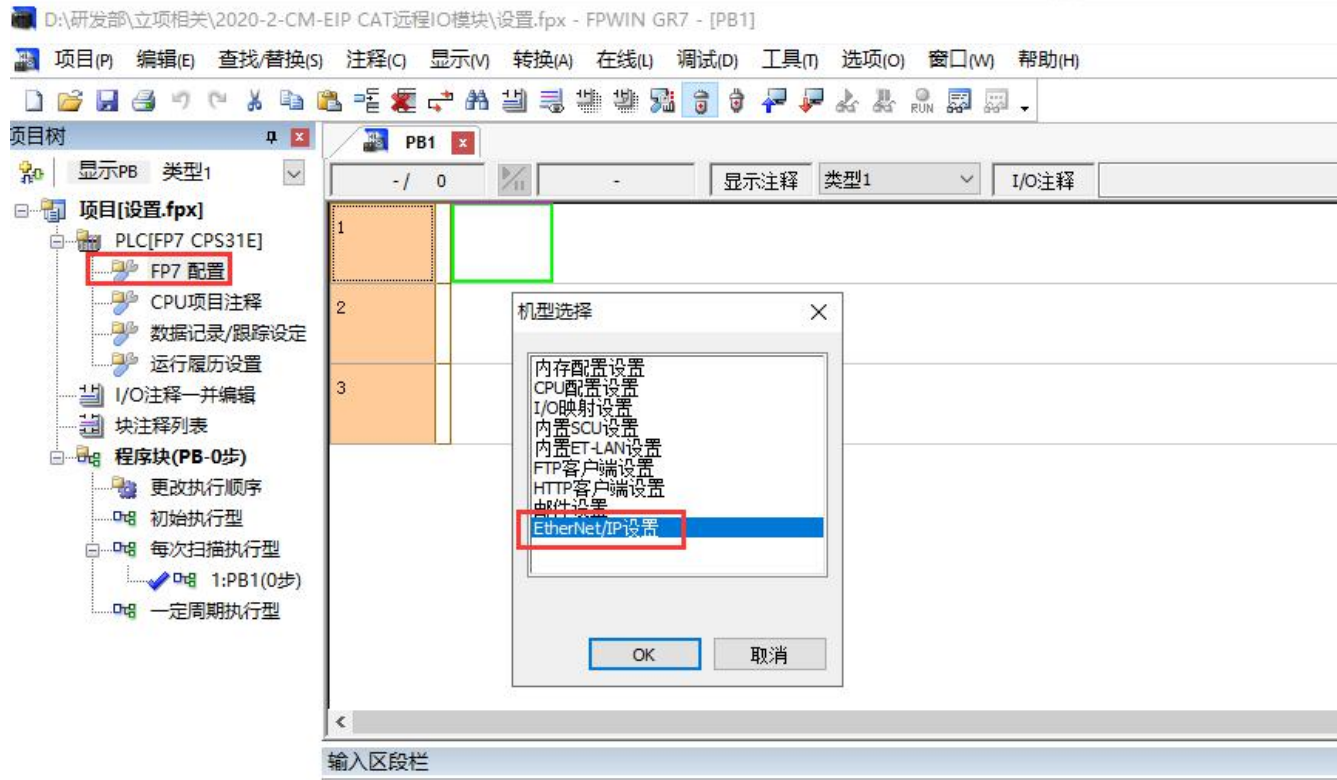

(2) Add input and output tags separately

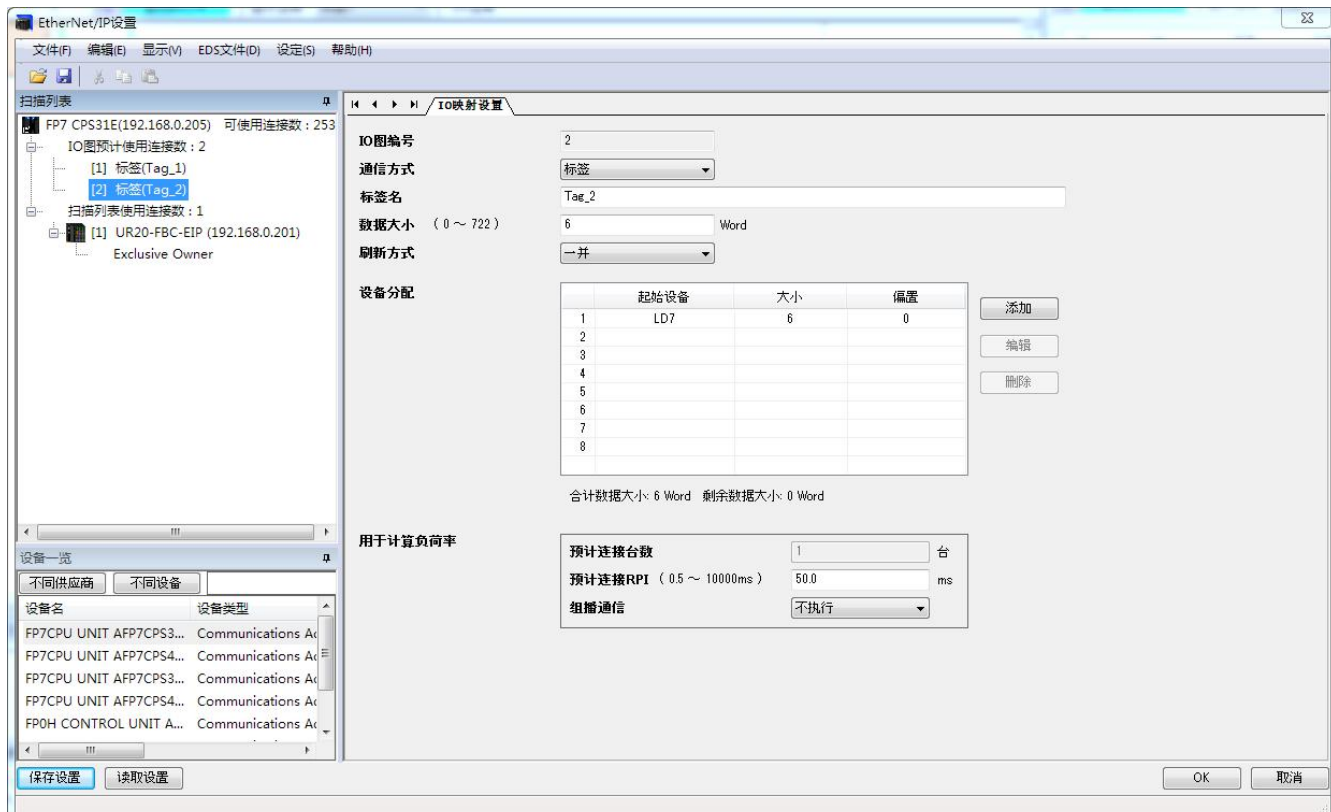
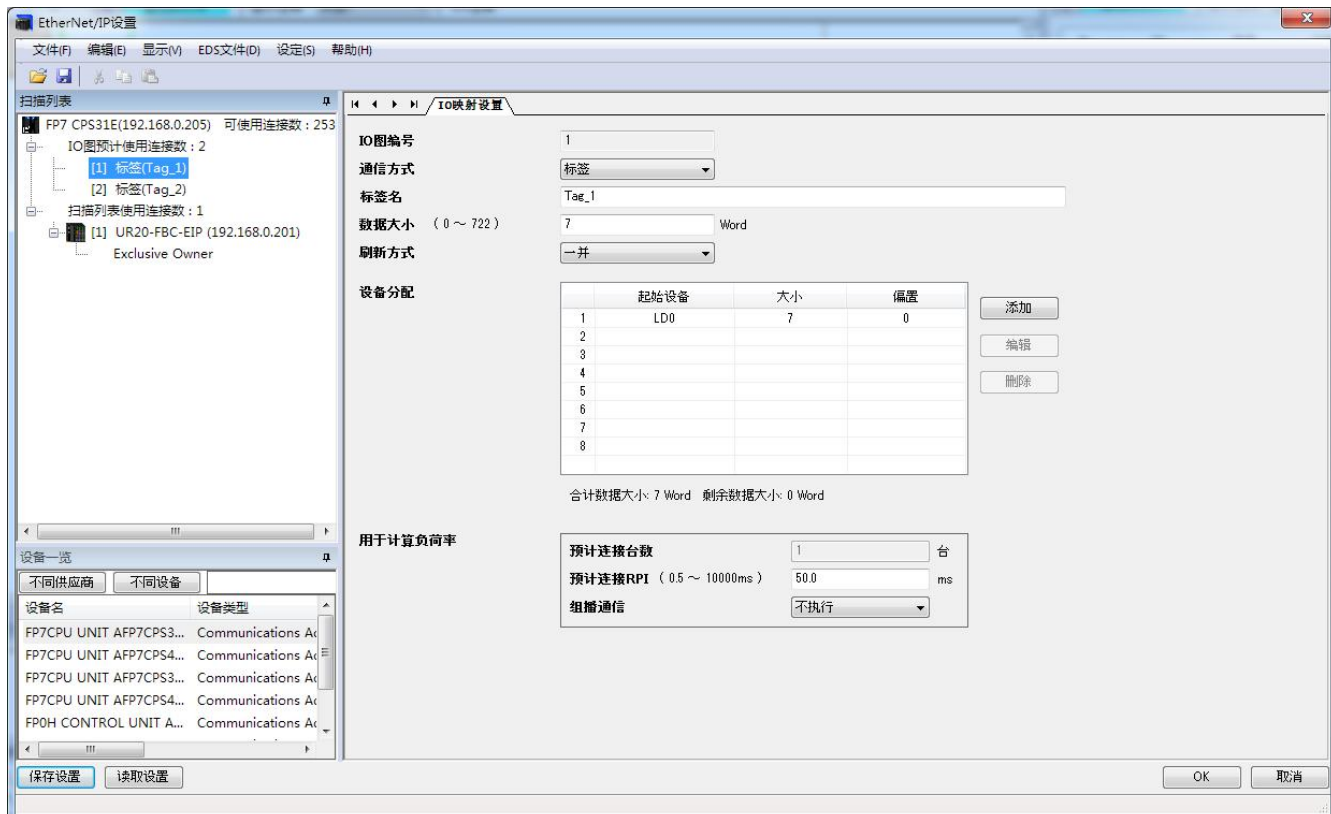

3.3.3. Add EDS equipment to the project

(1) Login EDS file



(2) Configured corresponding input connected to the output register

LD0 corresponds to the input of the module

LD7 corresponds to the output of the module

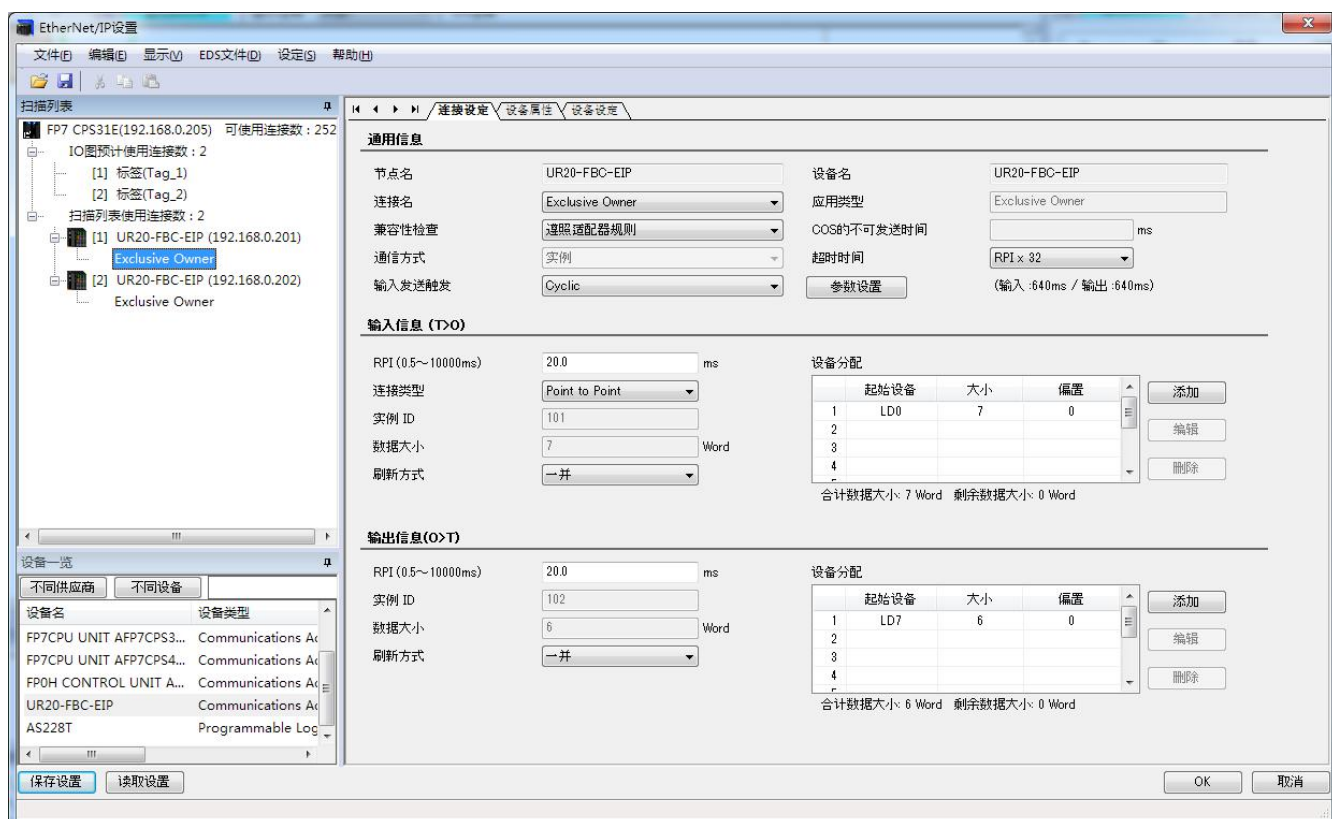

(3) After downloading to the PLC, connect to the Internet to run

3.4. NX1P2 PLC and L02-EIP for EtherNet/IP communication

In this example, NX1P2 PLC is used as the main control, and the connected module is L02-EIP. The specific operation steps are as follows.

In actual applications, please connect the hardware cables in advance.

3.4.1. Configure IP

(1) Open the built-in EtherNet/IP port setting, configure the local IP

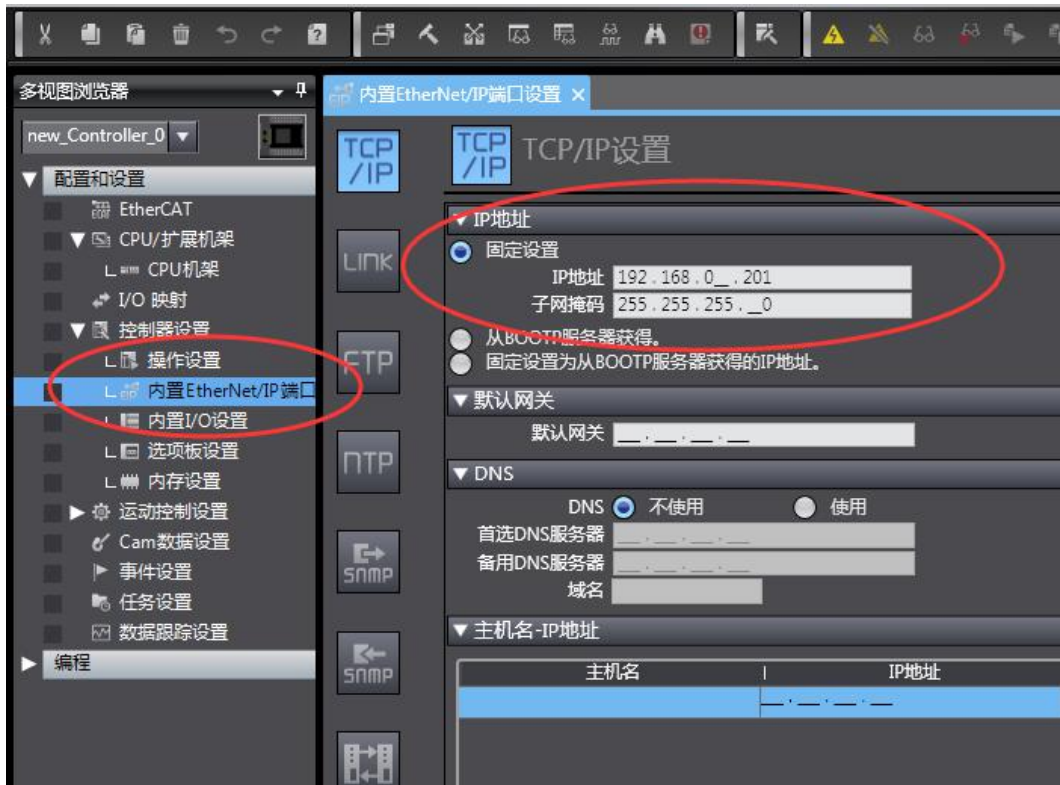

- (2) Add a global variable whose data type is WORD and the network public type is input and a global variable whose data type is WORD and the network public type is output.

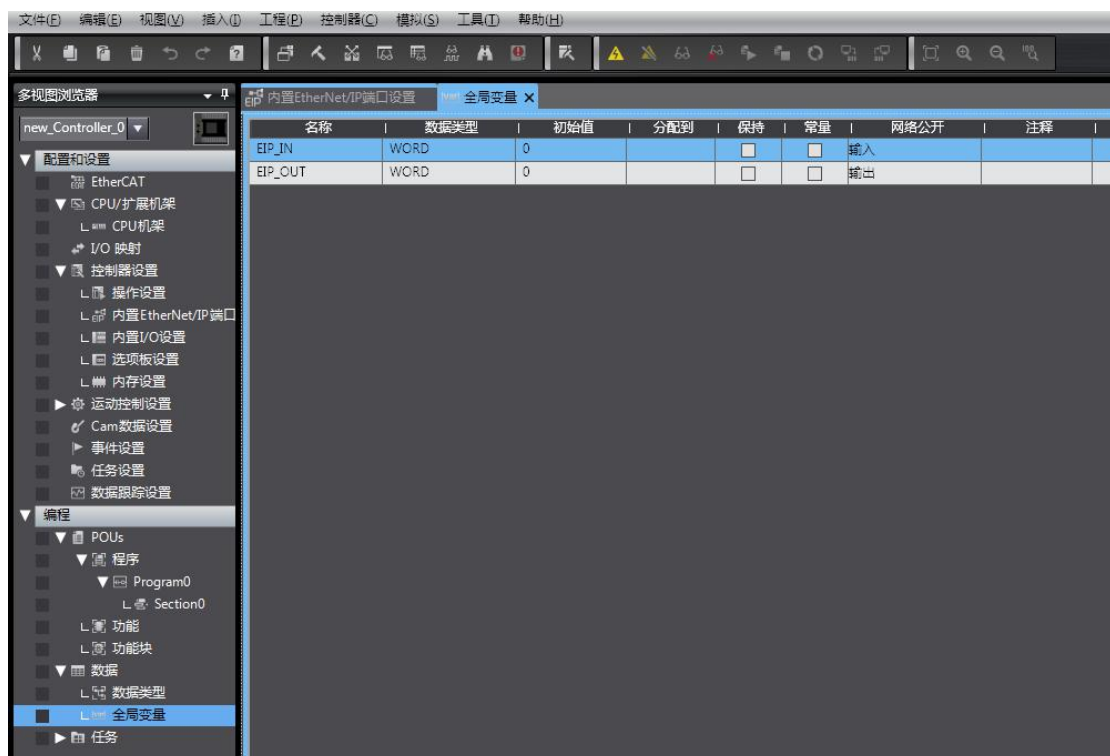

3.4.2. EtherNet/IP connection setting

(1) Tools>EtherNet/IP connection setting



(2) Double click the PLC name to open the setting

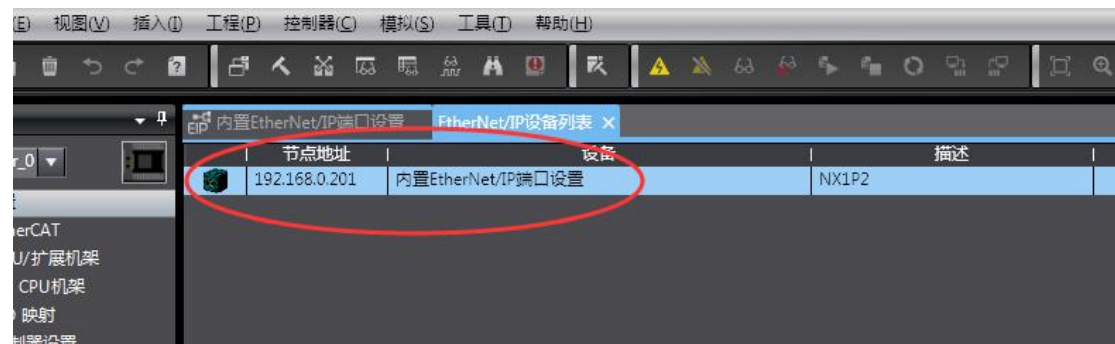

(3) Right-click on the target device in the toolbox on the right>Show EDS library

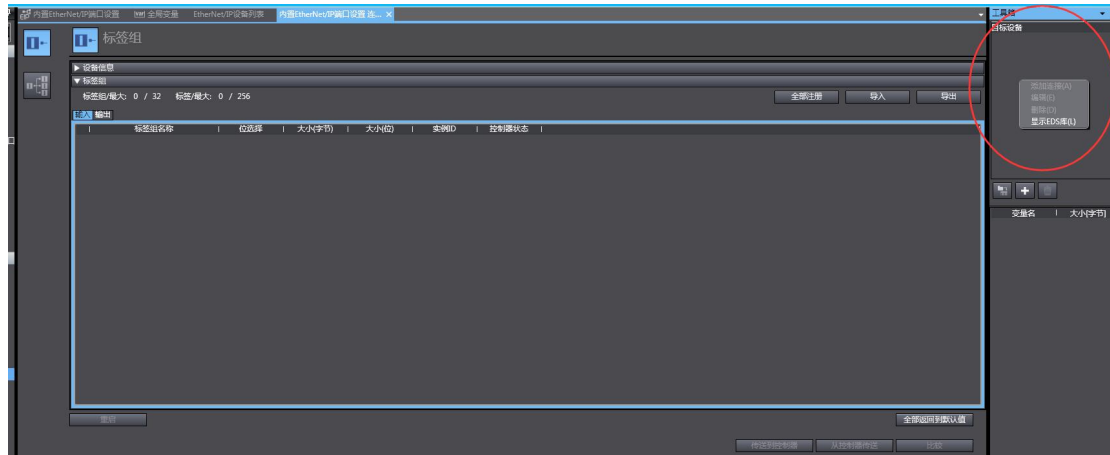

- (4) Click Install, select ethip-v1.5-weidmueller-ur20-fbc-EIP EDS file installation



(5) UR20-FBC-EIP will appear in the device list after installation



3.4.3. Add target device

- (1) Close the dialog box, click the + button under the target device to add the target device

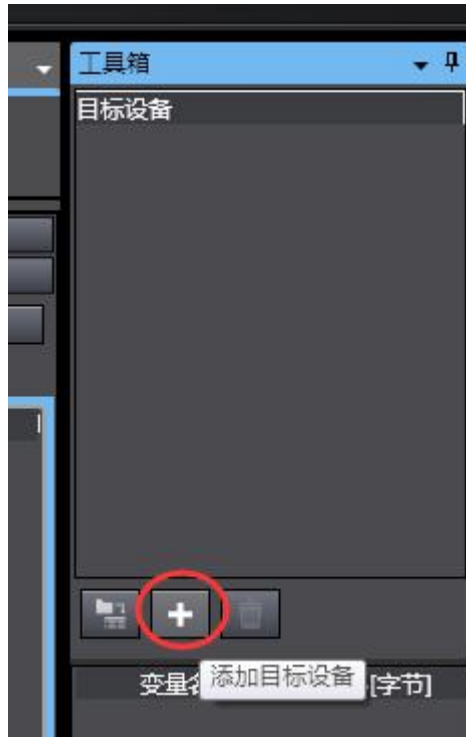

- (2) Enter the IP of the target device, select the model name as the newly added UR20-FBC-EIP, and select the version number



- (3) Click  button to complete the addition, then the target device appears the device we just added
- (4) Double-click UR20-FBC-EIP to add a device, set the node address and IP



3.4.4. Register variable

(1) To register variables, click Register all in the label group

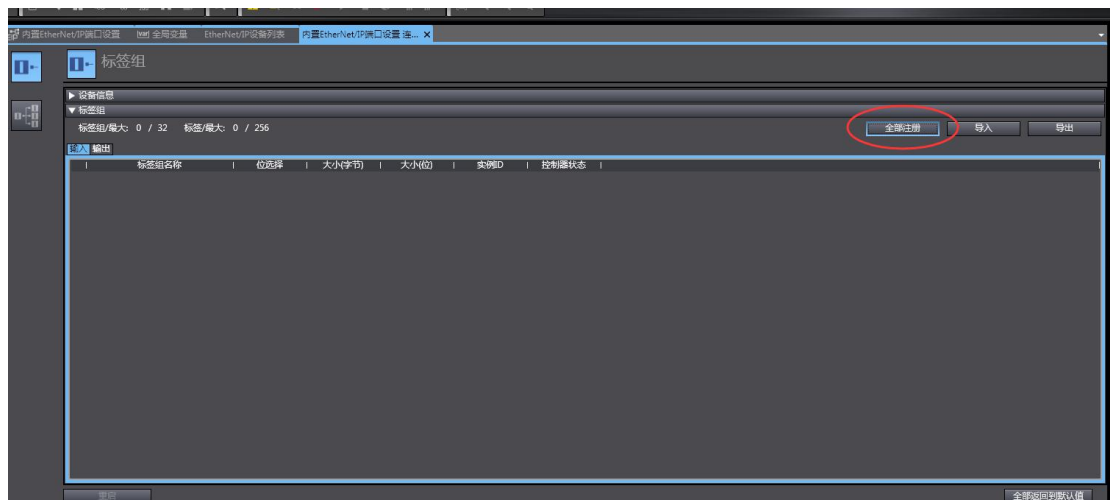

(2) Register the global variable we just created



(3) The variable we built appears in the input and output list



(4) Click on the connection icon on the left

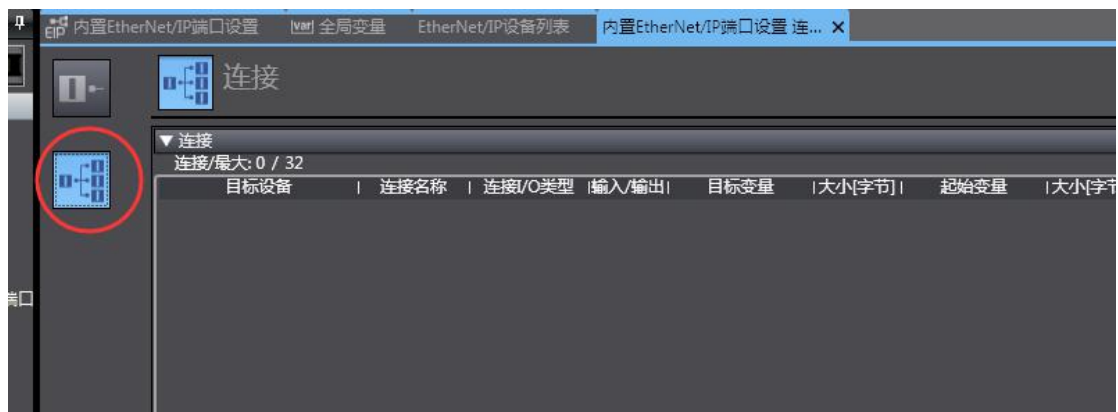

(5) Double-click the target device just added

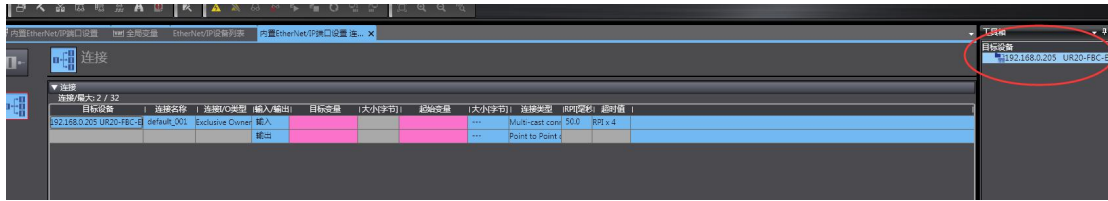

- (6) Fill in 101 in the input target variable, select EIP_IN as the starting variable
Fill in 102 in the output target variable, select EIP_OUT as the starting variable

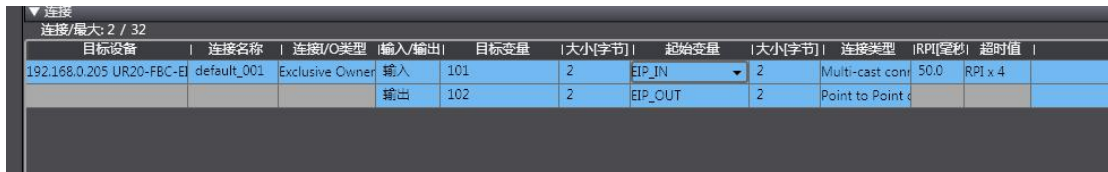

- (7) Download to PLC, pay attention to download EtherNet/IP connection settings together

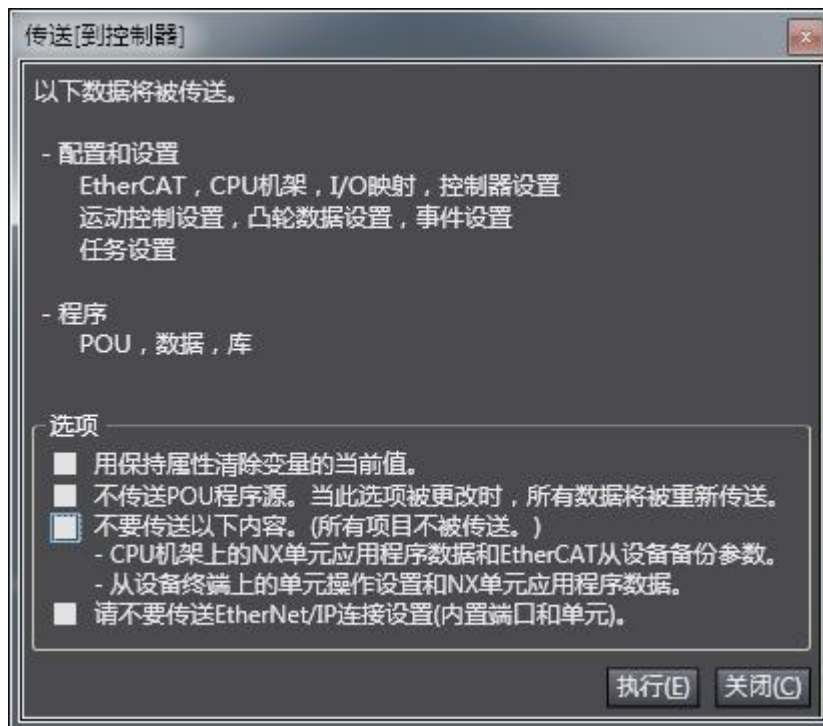

- (8) Open the monitoring window and connect the input to the module, then the value of EIP_IN will change in real time, Modify the value of EIP_OUT, the output of the module will also change accordingly.

监视(工程)1							
设备名称	名称	在线值	修改	注释	数据类型	分配到	显示格式
new_Controller_0	EIP_IN	0008			WORD		Hexadecim
new_Controller_0	EIP_OUT	0011	11		WORD		Hexadecim
new_Controller_0							