

# Inverter CM520

## User Manual

Shenzhen Coolmay Technology Co., Ltd

V7.11

# CATALOG

CATALOG.....	I
Chapter 1 Safety Instructions.....	1
In order to ensure the safety of your equipment and property, please read this chapter carefully before using the inverter and follow it in the future handling, installation, operation, commissioning and maintenance. Safety precautions in the manual are classified as “dangerous” and “warning”.....	
1.1 Security Definition.....	1
1.2 Installation Precautions.....	1
1.3 Precautions for use.....	3
1.3.1 Motor and mechanical loads.....	3
1.3.2 About the inverter.....	5
1.4 Disposal considerations.....	7
Chapter II Installation and Wiring.....	8
2.1 Installation environment requirements.....	8
2.2 Installation method.....	8
2.3 Wiring of the inverter.....	9
2.3.1 Main circuit terminal wiring.....	9
2.3.2 Control circuit wiring.....	11
2.3.3 Basic operation wiring.....	14
Chapter III Operation Instructions.....	15
3.1 Explanation.....	15
3.1.1 Inverter operation command channel.....	15
3.1.2 Frequency converter given channel.....	15
3.1.3 Working status of the inverter.....	16
3.2 Operation panel description.....	16
3.2.1 Button function description.....	16
3.2.2 Indicator instructions.....	17
3.2.3 Digital display area.....	17
3.3 Operation process.....	17
3.3.1 Function parameter setting.....	17
3.3.2 Monitoring parameter query.....	18
3.3.3 Fault reset.....	19
3.4 Inverter operation.....	19
3.4.1 Power-on initialization.....	19
3.4.2 Inverter operation.....	19
Chapter IV List of Function Parameters.....	22

1. Basic operating parameters (F0 parameters).....	22
2. Start/Stop parameter (F1 parameter) .....	25
3. Motor Parameters (F2 Parameter) .....	27
4. Vector control and VF control (F3 parameter) .....	29
5. Auxiliary operating parameters (F4 parameters).....	32
6. External input and output terminal definition (F5 parameter).....	34
7. PID Parameter (F6 parameter) .....	40
8. Multi-stage speed and PLC Parameter (F7 parameter) .....	41
9. Communication Parameter (F8 parameter) .....	44
10. Advanced Parameter (F9 parameter) .....	45
11. Enhance control parameters (FA parameters).....	46
12. Enhance PID Parameter (Fb parameter) .....	46
13. Protection parameter (Fd parameter) .....	47
14. Status monitoring parameter list.....	49
 Chapter 5 Fault treatment and solution.....	 51
This series of inverters records the fault code that occurred in the last 3 times and the inverter output parameters in the last fault. Querying these information will help user to find the cause of the fault.....	53
 Appendix 1 RS485 Communication Protocol.....	 54
1. Protocol Content.....	54
2. Application method.....	54
3. Bus structure.....	54
(1) Method of interface.....	54
(2) transfer method.....	54
(3) Topological structure.....	54
4. Protocol introduction.....	55
5. Communication frame structure.....	55
RTU frame standard structure.....	56
6. Command code and communication data description.....	57
6.1 Command code.....	57
6.2 Communication frame check mode.....	59
6.3 Communication address definition.....	62
 Appendix 2 Function Description.....	 64
1. Basic operating parameters (F0 parameters).....	64
1. Start and stop parameters (F1) .....	69
1. Motor parameters (F2 parameters).....	73
2. Vector control and VF control parameters (F3 parameters).....	74
3. Auxiliary operating parameters (F4 parameter) .....	78
4. External input and output terminal definition (F5 parameter).....	83
5. PID Parameter (F6 parameter).....	90
6. Multi-speed and PLC parameters (F7 parameters).....	92

7. Communication parameters (F8 parameters).....	96
8. Advanced parameters (F9 parameters).....	98
9. Enhanced control parameters (FA parameters).....	99
10. Enhanced function parameters (FB parameters).....	100
11. Protection parameter (Fd parameter).....	102
Appendix 3 Maintenance.....	106
1. Daily inspection and maintenance.....	106
2. Regular maintenance.....	107
2.1 Check content.....	107
3. Inspection and replacement of consumable parts.....	107
3.1 cooling fan.....	107
3.2 Filter capacitor.....	107
4. Storage and warranty.....	108
4.1 Storage.....	108
4.2 Warranty.....	108
Appendix 4 Inverter size.....	109
1. Single-phase inverter and three-phase mini inverter size (dimensions in mm)...	109
2. Three-phase inverter (dimension unit is mm).....	110

# Chapter 1 Safety Instructions

In order to ensure the safety of your equipment and property, please read this chapter carefully before using the inverter and follow it in the future handling, installation, operation, commissioning and maintenance. Safety precautions in the manual are classified as “dangerous” and “warning”.

## 1.1 Security Definition



Danger

This symbol indicates that it will cause death, serious injury, or serious property damage if not handled as required.



Alarm

This symbol indicates that if you do not follow the instructions, you may get bodily injury or equipment damage.

In some cases, it can cause to big accidents if failure to follow the instructions, even if it just violates the "warning". So in all cases, follow these important considerations.

## 1.2 Installation Precautions

- ◆ Install the inverter on a non-combustible object such as metal to prevent fire.
- ◆ Keep flammable materials away from the inverter, otherwise there is a danger of fire.
- ◆ Do not install the inverter in a flammable or explosive environment, otherwise there is a danger of explosion.
- ◆ It is strictly forbidden to disassemble and modify the inverter privately, otherwise the consequences will be at your own risk.
- ◆ Wiring must be performed by a qualified technician to avoid the risk of

electric shock.

- ◆ Do not open the cover or perform wiring work while the inverter is powered.
- ◆ The cover must be covered before the inverter is energized, otherwise there is danger of electric shock and explosion.
- ◆ For inverters that have been stored for more than 2 years, the voltage should be gradually increased by the voltage regulator before power-on, otherwise there is danger of electric shock or explosion.
- ◆ Do not touch the terminals by hand when power is on, otherwise there is danger of electric shock.
- ◆ Do not operate the inverter with wet hands, otherwise there is danger of electric shock.
- ◆ The maintenance operation can only be performed after the power is turned off for ten minutes. At this time, the indicator of the power supply is completely extinguished or the positive and negative bus voltages (P, N) are below 25V, otherwise there is danger of electric shock.
- ◆ Maintenance operations such as replacement parts must be carried out by professional technicians. It is strictly forbidden to leave metal objects such as wires or screws in the machine, otherwise there is a risk of fire.
- ◆ After the inverter is replaced with the new control board, the relevant parameters must be set correctly before its operating.
- ◆ Don't connect the output terminals U, V, W of the inverter to the AC power supply.



Alarm

- ▲ Do not allow the operation panel and cover to be stressed during transportation. Otherwise, the inverter may be partially damaged due to injury or damage to property.
- ▲ Installation should be carried out where it can withstand the weight of the inverter.

- ▲ Avoid installing the inverter in a place where water droplets may splash, otherwise there is a danger of damage to property.
- ▲ External objects are not allowed to put into the inverter.
- ▲ The ground terminal of the inverter must be well grounded.
- ▲ Do not touch the radiator with your hands within 10 minutes after power-on or power-off to prevent burns.
- ▲ If the inverter is damaged or the parts are not in conformity, please do not install or operate, otherwise there is danger of injury or property damage.
- ▲ Do not install in a place exposed to direct sunlight, otherwise there is a danger of damage to property.
- ▲ Do not short connect P/P(B)/N, otherwise there is a danger of fire and damage to property.
- ▲ The main circuit terminals and wires must be firmly connected.
- ▲ It is forbidden to connect the control terminal other than TA-TB-TC to AC 220V signal, otherwise there is danger of damage to property.

### **1.3 Precautions for use**

Please pay attention to the following points when using the CM520 series inverter:

#### **1.3.1 Motor and mechanical loads**

##### **Compared with power frequency operation**

The CM520 series inverter is a voltage type inverter, and its output voltage is PWM wave, which contains certain high-order harmonics. The temperature rise and vibration of the motor may occur during use, which is slightly increased compared with the power frequency operation.

##### **Constant torque low frequency operation**

When the inverter drives the ordinary motor for long-term low-speed and large-load operation, the increase of heat will deteriorate the insulation

performance of the motor and reduce the service life of the motor as the heat dissipation effect of the motor itself becomes worse. It is recommended to use the inverter motor or derating to use.

### **Electronic thermal protection value of the motor**

When the adapter motor is selected, the inverter can thermally protect the motor. If the rated capacity of the motor and the inverter do not match, the protection value must be adjusted or other protective measures must be taken to ensure the safety of the motor.

### **Running above 50Hz**

When the inverter's output frequency with the motor exceeds 50 Hz, consider the vibration and noise of the motor, and also ensure that the mechanical components such as the motor bearings are within the speed range used.

### **Lubrication of mechanical devices**

This inverter drives gearboxes such as gearboxes and gears that require lubrication. When the long-term low-speed operation is performed, the lubrication effect may be deteriorated, which may cause damage. It is recommended to check or maintain in advance.

### **Negative torque load**

In the case of lifting the load, there is often a negative torque, and the inverter often trips with overcurrent and overvoltage faults. At this time, the brake component with the appropriate parameters should be selected.

### **Mechanical resonance point of the load device**

The inverter may encounter the mechanical resonance point of the load device within a certain output frequency range, and can be avoided by setting the jump frequency.

### **Frequent start and stop occasions**

For frequent start and stop, please start and stop the inverter through external



terminals or panels. It is strictly forbidden to use the switching device such as contactor on the input side of the inverter for direct frequent start and stop operation, otherwise the equipment may be damaged.

### Motor insulation check before connecting to the inverter

Before using the motor for the first time or after long-term use, please check the motor insulation to prevent damage to the inverter due to motor insulation failure. For the test, please use the 500V voltage type megohmmeter, and ensure that the measured insulation resistance is not less than 5MΩ.

### 1.3.2 About the inverter

#### Capacitors and varistors with improved power factor

Since the inverter output U, V, W voltage waveform is PWM wave, if the capacitor with improved power factor or varistor for lightning protection is installed on the output side, it will cause the inverter to malfunction or damage the device. Please remove it. The schematic diagram of disabling the capacitor at the output of the inverter is shown in Figure 1-1:

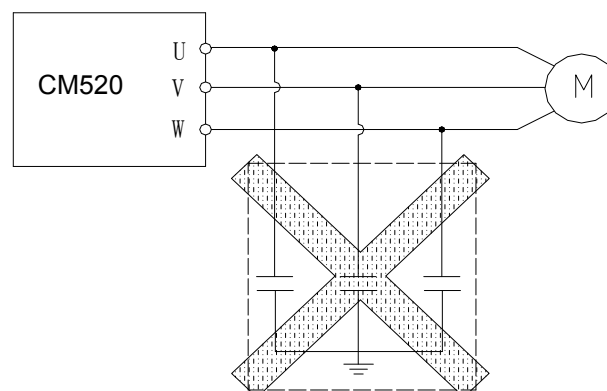

Figure 1-1 Schematic diagram of capacitors disabled at the output of the inverter

#### Switching device such as contactor installed at the output of the inverter

If it is necessary to install a switching device such as a contactor between the inverter output and the motor, please ensure that the inverter performs the

on/off operation when there is no output, otherwise the inverter may be damaged.

### Use outside of rated voltage

The inverter is not suitable for use outside the operating voltage range. If necessary, use a corresponding step-up or step-down device for voltage transformation.

### Three-phase input to two-phase input

It is recommended not to change the two-phase to two-phase, if it is really necessary to change to two-phase input and derate it.

### Altitude and derating

In areas where the altitude is more than 1000 meters, the heat dissipation efficiency of the inverter is reduced due to the thin air, and it needs to be derated. Figure 1-1 below shows the relationship between the rated output current of the inverter and the altitude derating.

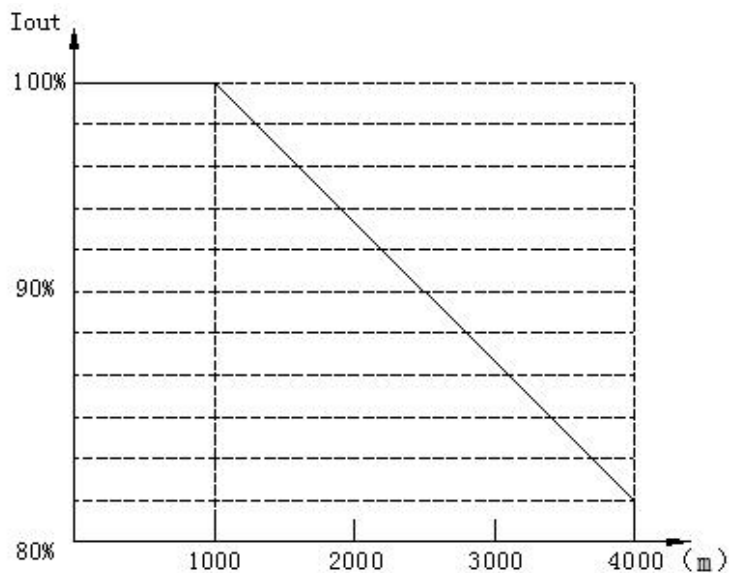

Figure 1- 1 The relationship between the rated output current of the inverter and the altitude derating

### Inverter output reactor

When the wiring between the inverter and the motor is long, a high  $dV/dt$  will be generated inside the coil of the motor, which will damage the interlayer insulation of the motor. Please use a variable frequency motor or install an AC

output reactor on the output side.

#### **1.4 Disposal considerations**

When dealing with scrapped inverters and components, please consider the notes below.

**Electrolytic Capacitor:** Electrolytic capacitors in the inverter may explode when incinerated.

**Plastic:** Plastic and rubber products on the inverter may produce toxic and harmful gases when burning. Please be careful when burning.

**Cleaning:** Please dispose of the scrapped inverter as industrial waste.

## Chapter II Installation and Wiring

### 2.1 Installation environment requirements

1. Install it in an indoor place with a vent or ventilator. It should be installed vertically.
2. The ambient temperature is  $-10^{\circ}\text{C} \sim 40^{\circ}\text{C}$ . If the temperature exceeds  $40^{\circ}\text{C}$ , forced cooling or derating should be used.
3. Try to avoid high temperature and humidity, humidity less than 95%, and no frost and water condensation.
4. Avoid installation in direct sunlight.
5. Avoid installation in environments with flammable, explosive and corrosive gases and liquids.
6. It should be installed in an environment free of dust, floating fibers and metal particles.
7. The mounting surface is rugged, vibration free, or vibration less than  $5.9\text{ m/s}^2$  ( $0.6\text{ g}$ ).
8. Keep away from sources of electromagnetic interference.

### 2.2 Installation method

This series of frequency converters are wall-mounted inverters, which should be installed vertically to facilitate air circulation and heat dissipation. There should be enough space around the inverter. The location of the ventilation fan in the installation environment of the inverter is shown in Figure 2-1.

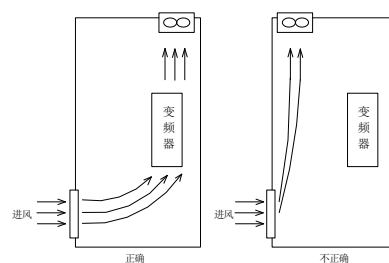

Figure 2-1 Fan position in the inverter installation environment

For the installation of multiple wall-mounted inverters, as shown in Figure 2-2 and Figure 2-3; if installing in the same vertical direction, please pay attention to the intermediate application of the baffle, as shown in Figure 2-2.

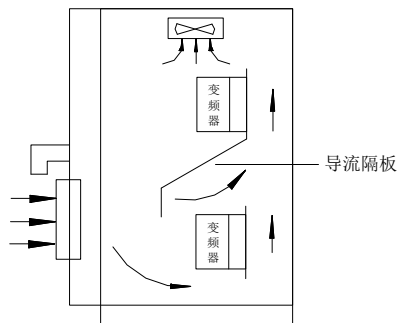

Figure 2-2

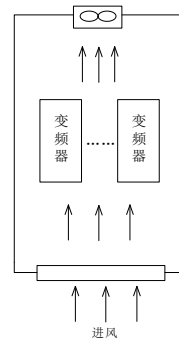

Figure 2-3

## 2.3 Wiring of the inverter

### 2.3.1 Main circuit terminal wiring

**Firstly, the connection between the inverter and optional accessories.**

1. Between the power grid and the inverter, an obvious disconnecting device such as an isolating switch must be added to ensure the safety of the equipment during maintenance.
2. There must be a circuit breaker or fuse with overcurrent protection before the inverter to avoid the scope of the fault of the rear equipment.
3. When the inverter is used for power supply control, it cannot be used to control the start and stop of the inverter.
4. When the waveform distortion of the power grid is serious, or the inverter reacts with the DC reactor, the mutual influence of the higher harmonics between the power supply and the inverter cannot meet the requirements, or the power factor of the input side of the inverter can be increased. AC input reactor.
5. The input side EMI filter can suppress high frequency noise interference from the inverter power line.
6. In order to protect the inverter and suppress higher harmonics, protect the

power supply from affecting the inverter. In the following cases, please configure the DC reactor.

a. When there is a switch-type reactive compensation capacitor cabinet or a thyristor phase-controlled load on the same power supply node that supplies power to the inverter, the reactive voltage transient is caused by the switching of the capacitor cabinet switch, resulting in sudden change of the network voltage and phase-controlled load. The resulting harmonics and grid gaps may cause damage to the inverter input rectifier bridge circuit.

b. When it is required to increase the power input of the inverter to 0.93 or above, when the unbalance of the three-phase power supply exceeds 3%, when the inverter is connected to the large-capacity transformer, the current flowing through the input power supply loop of the inverter May cause damage to the rectifier circuit. When the capacity of the inverter power supply is greater than 550KVA, or when the power supply capacity is greater than 10 times the inverter capacity, a DC reactor is required.

### Secondly, the main circuit terminal block description

The wiring diagram of the main circuit terminal block is shown in Figure 2-4.

The function description table of each terminal is as follows.

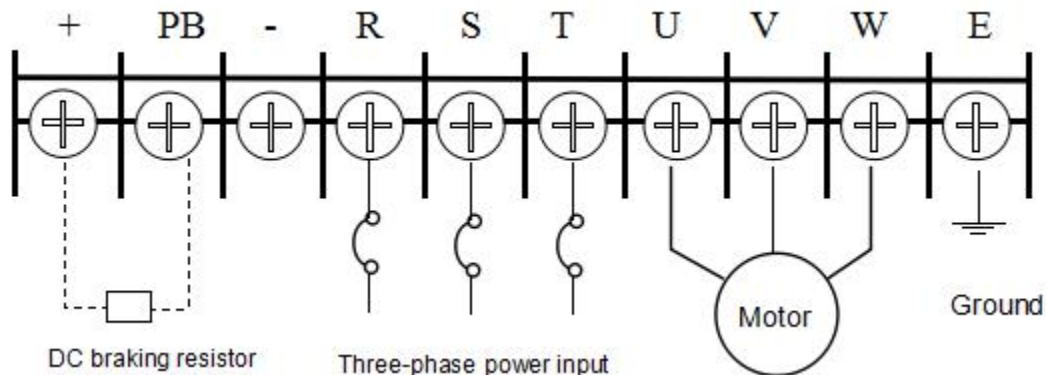

Figure 2-4 Main circuit terminal block wiring diagram

**Terminal functions description**

Terminal symbols	Functions description
+、-	DC side voltage positive and negative terminals
PB	+, PB can be connected to DC braking resistor
R、S、T	Connect to the grid three-phase AC power supply
U、V、W	Connect to three-phase AC motor
E	Ground terminal

**2.3.2 Control circuit wiring**

**Firstly, control circuit terminal diagram**



a) Standard model control board terminal

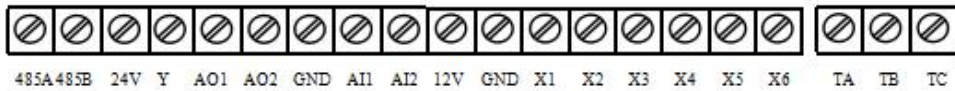

b) Mini machine control board terminal

Figure 2-5 Wiring diagram of the control circuit terminal block

**Secondly, the control circuit terminal function description**

Type	Terminal symbols	Terminal functions	Remark
Power output	12V	12V/10mA	
	GND	The common end of the frequency setting voltage signal (12V, power ground), the analog current signal input negative terminal (current inflow end)	

	24V	24V/50mA power supply provided externally (GND terminal is the power ground)	
Analog input Input AI1 analog voltage signal input 1 AI2 analog voltage / current signal input 2	AI1	Analog voltage signal input 1	0~10V
	AI2	Analog voltage/ current signal input 1	0~10V/0~20MA
Digital input (control terminals)	PM	Terminal active level selection terminal	PM is connected to the power supply, and the multi-function terminal and GND terminal are closed. PM is connected to GND, and the multi-function terminal and power terminal are closed.
	X1	Multi-functional input terminals 1	
	X2	Multi-functional input terminals 2	
	X3	Multi-functional input terminals 3	
	X4	Multi-functional input terminals 4	
	X5	Multi-functional input terminals 5	
	X6	Multi-function input terminal 6, can also be used as input terminal for external pulse signal	The specific functions of the multi-function input terminal are set by parameters (F5-16~F5-21)
Analog outputs	AO1	Programmable voltage output (F5-34~F5-36 parameter determination).	Voltage output 0~10V
	AO2	Programmable voltage, current and frequency output terminals (F5-39~F5-43 parameters are determined).	The highest output signal frequency is 50KHz and the amplitude is 10V.
OC output	Y	Programmable open collector output, set by parameter F5-27.	Maximum load current 50mA, maximum withstand voltage 24V.
Programmable relay output	TA-TB-TC 1	Programmable relay output, set by parameter F5-28 F5-29	Contact capacity: AC250V 1A



	TA-TB-TC 2		Resistive load
RS485 COM	485A 485B	RS485 COM terminals	

### Thirdly, jumper instructions

#### 1. Standard machine control board

##### SW1 dial switch: AO2 output selection

The DIP switch is at the top, and the AO2 output is 0~10V.

The DIP switch is dialed in the middle, and AO2 outputs 0~20mA.

The DIP switch is dialed at the bottom, and AO2 outputs a high-speed pulse signal.

##### SW2 DIP switch: AI2 output selection

The DIP switch is dialed at the top and AI2 is input 0~10V.

DIP switch is dialed below, AI2 input 0~20mA.

#### 2. Mini machine control board

CN1: Dialed on top, PM is connected to GND, multi-function terminal (X?) is valid when connected to power supply; dialed below, PM is connected to 12V, and multi-function terminal (X?) is connected to ground.

2.3.3 Basic operation wiring

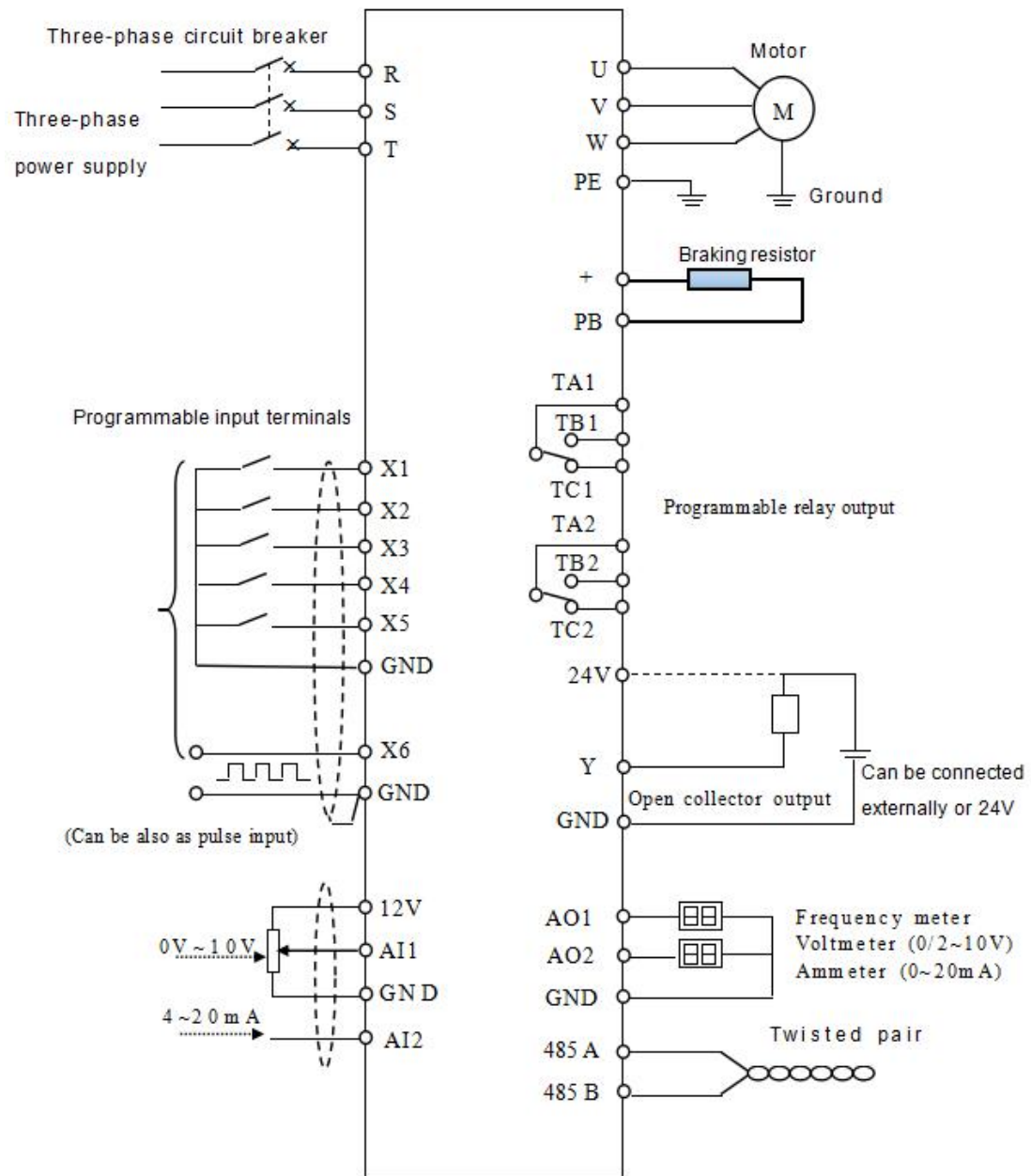

Figure 2-6 Basic operation wiring diagram

## Chapter III Operation Instructions

### 3.1 Explanation

The nouns describing the control, operation and status of the frequency converter are used several times in later chapters. Please read this chapter carefully to help understand and use the features mentioned later.

#### 3.1.1 Inverter operation command channel

It refers to the physical channel that the inverter accepts operations such as running, stopping, jogging, etc. It has three types:

Operation panel: Control through the RUN, STOP and MF.K keys on the operation panel

External terminal: controlled by FWD, REV, COM, Si (three-wire control)

485 interface: start and stop control through the host computer

The command operation channel selection can be determined by F0-02.

When the external terminal is selected for control, the external terminal control mode must be further determined by F5-15, including two-wire type 1, two-wire type 2 and three-line control 1, and three-wire control 2.

#### 3.1.2 Frequency converter given channel

The CM520 has several independent frequency reference channels.

0: Keyboard potentiometer given

1: The keyboard rises and the down button determines the running frequency.

2: AI1 (0-10V/0~20mA)

3: AI2 (0-10V/0~20mA)

4: Reserved

5: PID closed loop given frequency

6: Multi-speed control

7: PLC given

8: UP/DW terminal given

9: Communication Control

10: Reserved

11: Given high speed pulse

Various frequency reference channels can also be given as the last frequency after various combinations (see the description of F0-03~F0-06 for details)

### 3.1.3 Working status of the inverter

The working status of the CM520 is divided into stop status, running status and fault status.

**Stop status:** After the inverter is powered on, if the inverter is not input to the inverter or the stop command is input during operation, the inverter will enter the stop command.

**Operating status:** After receiving the running command, the inverter enters the running state.

**Fault status:** The inverter is notified of fault or external fault. The inverter blocks the output (the output voltage is 0 at this time) and is in a fault state.

## 3.2 Operation panel description

### 3.2.1 Button function description

Button symbols	Name	Functions
PRG	Menu	Menu entry or exit
SET	Enter	Enter the menu step by step, set the parameter confirmation
⤴	UP	Increment of data or function code
⤵	DW	Decrease in data or function code
⬅	Shift	In the running monitoring state, press this button to cycle display the set monitoring parameters. While modifying the parameters, you can select the parameter modification bits.
RUN	RUN	In keyboard operation mode, used for running operations

MF.K	Multifunction key	Determined according to F4-31
<u>STOP</u> RESET	<u>STOP</u> RESET	In the running state, this button can be used to stop the running operation (F0-02 is determined). In the fault state, the fault operation can be reset.

### 3.2.2 Indicator instructions

Symbols	Indicator instructions
Hz	Frequency unit
A	Current unit (Ampere)
V	Voltage unit (Volt)
FWD	Forward running indicator
REV	Reverse running indicator FWD, REV flashes at the same time represents DC braking
ALM	Alarm indicator (overcurrent, overvoltage but alarm when the fault level has not been reached)

### 3.2.3 Digital display area

The 5-digit LED display can display various monitoring data such as set frequency and output frequency as well as alarm codes.

## 3.3 Operation process

### 3.3.1 Function parameter setting

The three levels of menu are:

1. Function code parameters (first level menu)
2. Function code label (secondary menu)
3. Function code set value (third level menu)

Note: During the three-level menu operation, you can press the PRG button or SET button to return to the secondary menu. The difference between the two is: press the SET button to save the setting parameters to the control panel, and then return to the secondary menu; press the PRG button to return

directly to the secondary menu, without storing parameters.

Example: Change the function code F1-01 from 0.00Hz to 5.00Hz, as shown in Figure 3-1.

**3.3.2 Monitoring parameter query**

There are two situations for monitoring parameter query. On one hand, when the inverter is running, press “◀◀” to cycle display the three most commonly used parameters of the user (determined by F4-26, F4-27, F4-28). On the other hand, view the status parameters that the user cares about by checking the d parameter.

Example: Check the value of inverter d-02 (inverter output current value), as shown in Figure 3-2.

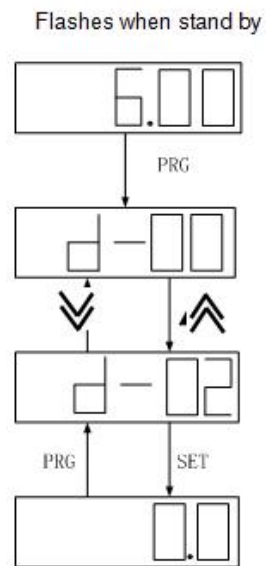
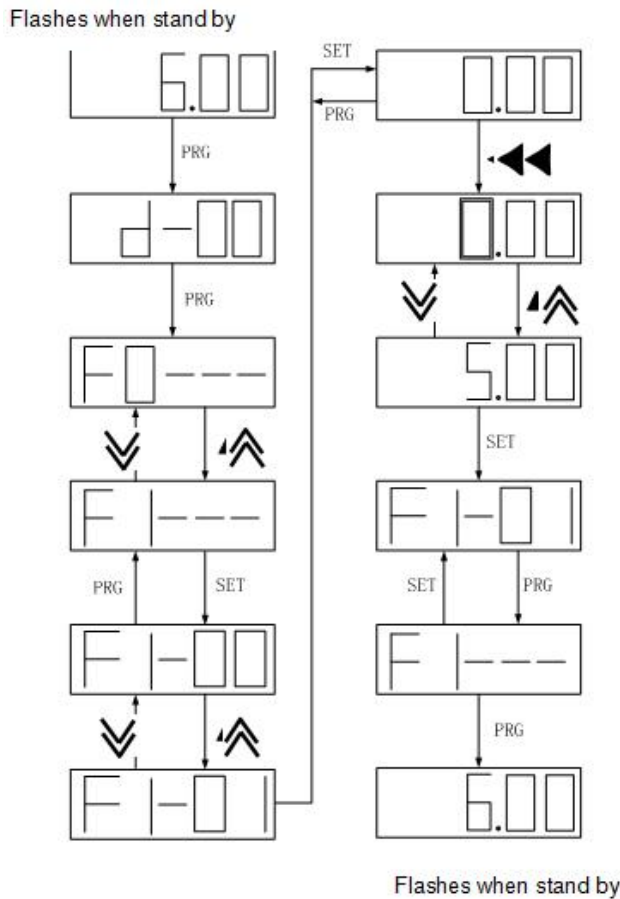

Figure 3-1 Flowchart for modifying function parameters

Figure 3-2 Flowchart for Viewing status parameters

### 3.3.3 Fault reset

After the inverter fails, the inverter will prompt the relevant fault information. The user can reset by “STOP/RESET” on the keyboard or external terminal function (F5 group setting). After the inverter fault is reset, it is in the standby state. If the inverter is in a fault state and the user does not reset it, the inverter is in the running protection state and the inverter cannot be operated.

## 3.4 Inverter operation

### 3.4.1 Power-on initialization

During the power-on process of the inverter, the system first initializes, the DC bus voltage of the inverter is from low to high, and the LED display is “-SGd-”. When the voltage value reaches a certain value, the inverter is in the standby state, and the LED is displayed as the set frequency. And it is always flashing.

### 3.4.2 Inverter operation

The drive can be started via keypad control, external terminals or communication (see F0-02). The user can monitor 22 state variables (see d parameter) while the drive is running.

#### **Firstly, the keyboard control ([F0-02] = 0)**

Press the “RUN” button, the inverter runs in the forward direction, press “STOP/RESET” to stop the inverter. According to the F4-31 setting, “MF.K” can be used as the reverse button. If you press “MF.K”, it will run in reverse.

#### **Secondly, the terminal control ([F0-02] = 1)**

When selecting the terminal control mode, you need to select specific terminal control mode according to the actual site needs. The CM520 inverter provides four terminal control modes, which are selected according to F5-15. FWD selects the forward rotation function for the external multi-function input terminal, which is recorded as FWD.

REV selects the invert function for the external multi-function input terminal,

which is referred to as REV.

**0: Two-wire control mode 1**

Command	Stop	Run	Forward command	Reverse command
Terminal state				

**1: Two-wire control mode 2**

Command	Stop		Forward command	Reverse command
Terminal state				

**2: Three-wire control mode 1**

A three-wire control terminal must be selected (see parameters F5-16 to F5-21 for instructions). The wiring diagram of the three-wire control mode is shown in Figure 3-3.a.

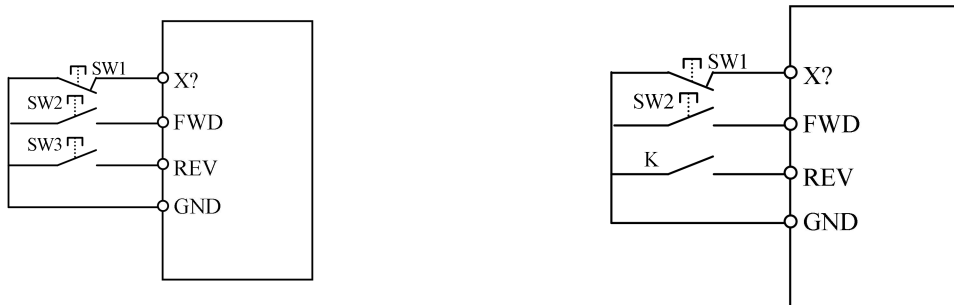

a) Three-wire control mode 1 wiring diagram      b) Three-wire control mode 2 wiring diagram

Figure 3-3 Three-wire control mode wiring diagram

X? is the three-wire operation control terminal, one of the input terminals X1 to X6 is selected by parameters F5-16 to F5-21. SW1 is the inverter stop trigger switch, SW2 is the forward rotation trigger switch, and SW3 is the reverse rotation trigger switch.

**3: Three-wire control mode 2**



X? is the three-wire operation control terminal, one of the input terminals X1 to X6 is selected by parameters F5-16 to F5-21. SW1 is the inverter stop trigger switch, SW2 is the forward rotation trigger switch, and K is the reverse switch.

**Thirdly, the communication control refers to the appendix.**

## Chapter IV List of Function Parameters

Instructions of the symbols in the table.

☆ —— The parameter can be changed during shutdown and operation.

× ——The parameter can be changed in the stop state and cannot be changed during the running.

\* ——The initial value of this parameter is related to the model number of the inverter.

### 1. Basic operating parameters (F0 parameters)

Code	Name	Descriptions	Minimum unit	Factory set	Change bit
F0-00	Model selection	0: universal 1: Type P machine	1	0	×
F0-01	Control mode	0: VFcontrol 1: Vectorized VF control 2: Non-inductive vector control 1 3: Non-inductive vector control 2	1	0	×
F0-02	Operation command channel selection	0: Panel control 1: External terminals 2: RS485 terminals	1	0	☆

F0-03	The main frequency setting source is selected as A	0:Keyboard potentiometer given 1: The keyboard rises and the down button determines the running frequency. 2: AI1 (0-10V) 3: AI2 (0-10V/0~20mA) 5: PID closed loop given frequency 6: Multi-speed control 7: PLC given 8: UP/DW terminal given 9:Communication control 11:High speed pulse given	1	0	☆
F0-04	Auxiliary frequency setting source selection B	0:Keyboard potentiometer 1: AI1 ( 0- 10V ) 2: AI2 ( 0-10V ) 3: F0-07 4: High speed pulse given 5: Multi speed	1	1	☆
F0-05	Auxiliary frequency B reference object selection	0: upper frequency limit 1: Main frequency given A	1	0	☆

F0-06	Set frequency combination	0: Frequency A given 1: Frequency B given 2: A+B 3: MAX (A, B) 4: MIN (A, B) 5: A-B	1	0	☆
F0-07	Keyboard up/down button setting	0~Upper limit frequency	0.01	50.00	☆
F0-08	Upper limit frequency	5.00~650.00 Hz	0.01	50.00	×
F0-09	Lower limit frequency	0.00Hz ~ F0-08	0.01	0.50	×
F0-10	Lower limit frequency RUN MODE	0: run as Lower limit frequency 1: power off 2: sleep standby	1	0	×
F0-11	Sleep wake-up time	0.0~6000.0 s	0.1	0.0	×
F0-12	Acceleration time 1	0.1~6000.0 s	0.1	*	☆
F0-13	Deceleration time1	0.1~6000.0 s	0.1	*	☆
F0-14	Carrier frequency	1 ~ 10KHz	1	*	☆

F0-15	Drive Run direction	0: run as set direction 1: run as opposite direction 2: reverse running is prohibited	1	0	☆
F0-16	Parameter on standby	0~39 ( correspond to d parameter)	1	3	☆
F0-17	Factory reset	0: Does't work 11: Parameter initialization 22: Clear all fault records	1	0	×
F0-18	Parameter write-protect	0: No protection 1: Parameters can't be changed	1	0	×
F0-19	STOP key action range	0: Panel control is valid 1: all commands are valid	1	1	×

## 2. Start/Stop parameter (F1 parameter)

Code	Name	Description	Minimum unit	Factory set	Change Limit
F1-00	Start mode	0: started by the start frequency 1: brake first, restart 2: Speed tracking, restart	1	0	×
F1-01	Start frequency	0.00~10.00Hz	0.01	0.50	×
F1-02	Start frequency duration	0.0~20.0 s	0.1	0.0	×

F1-03	Start DC braking current	0~150.0%	1	50.0	×
F1-04	Start DC braking time	0.0~30.0 s	0.1	0.0	×
F1-05	Stop mode	0: Deceleration stop 1: Free stop	1	0	☆
F1-06	Stop DC braking start frequency	0.00~50.00Hz	0.01	3.00	×
F1-07	Stop DC braking current	0~150.0%	1	50.0	×
F1-08	Stop DC braking action time	0.0~60.0 s	0.1	0.0	×
F1-09	Speed tracking algorithm selection	0: minimum current method 1: voltage frequency method	1	0	×
F1-10	Speed tracking wait time	0.0 ~ 10.0 s	0.1	1.0	×
F1-11	Speed tracking search time	3.0 ~ 100.0 s	0.1	6.0	×
F1-12	Speed tracking complete conditions	Current 1.00~50.00%	0.01	15.00	×
F1-13	Brake starting voltage	105.0~140.0%	0.1	123.0	☆
F1-14	Brake termination voltage	105.0~150.0%	0.1	128.0	☆
F1-15	Power-on running detection	0: power-on running command is invalid 1: power-on running command is valid	1	0	×

F1-16	Stop speed	0.00~100.00%	0.01	1.00	☆
F1-17	Stop speed detection mode	0: Check out by speed setting value 1: Check out by actual speed (for vector control)	1	1	☆

### 3 .Motor Parameters (F2 Parameter)

Code	Name	Description	Minimum unit	Factory set	Change Limit
F2-00	Motor type	0: asynchronous motor 1: permanent magnet synchronous motor	1	0	×
F2-01	Rated motor voltage	1~700V	1	*	×
F2-02	Rated motor frequency	5.00~600.00Hz	0.01	50.00	×
F2-03	Rated motor current	0.1~3000.0A	0.1	*	×
F2-04	Rated slip frequency	0.00~5.00Hz	0.01	*	×
F2-05	Number of pole pairs	1~50	1	2	×
F2-06	No-load current	10.0~ 80.0%	0.1	*	×
F2-07	Stator resistance	0.00~50.00%	0.01	*	×
F2-08	Rotor resistance	0.00~50.00%	0.01	*	×
F2-09	Leakage resistance	0.00~50.00%	0.01	*	×
F2-10	Motor self-tuning parameter	0: no action 1: static tuning 2: Complete tuning	1	0	×
F2-11	Permanent magnet	5.00~600.00Hz	0.01	50.00	×

	synchronous motor rated frequency				
F2-12	Permanent magnet synchronous motor rated voltage	1~700V	1	*	×
F2-13	Permanent magnet synchronous motor rated current	0.1~3000.0A	0.1	*	×
F2-14	Permanent magnet synchronous motor rated back EMF	1~700V	1	*	×
F2-15	Permanent magnet synchronous motor stator resistance	0.00~50.00%	0.01	*	×
F2-16	Active damping detection time	2~100	1	10	×
F2-17	Active damping coefficient 1	0~1000	1	100	×
F2-18	Active damping coefficient 2	0~1000	1	100	×
F2-19	Active damping switching frequency	0.00~100.00Hz	0.01	100.00	×
F2-20	Active damping limiter	0.00~3.00Hz	0.01	1.00	×
F2-21	Voltage compensation coefficient	0.0~60.00%	0.01	15.00	×



#### 4. Vector control and VF control (F3 parameter)

Code	Name	Description	Minimum unit	Factory set	Change Limit
F3-00	Low speed ASR scale coefficient	0.01 ~ 30.00	0.01	0.60	☆
F3-01	Low speed ASR integral coefficient	0.01 ~ 10.00	0.01	1.00	☆
F3-02	ASR switching frequency 1	1.00~7.50Hz	0.01	5.00	☆
F3-03	High speed ASR scale coefficient	0.01 ~ 30.00	0.01	0.60	☆
F3-04	High speed ASR integral coefficient	0.01 ~ 10.00	0.01	1.00	☆
F3-05	ASR switching frequency 2	8.00~50.00Hz	0.01	10.00	☆
F3-06	Current loop proportional coefficient	0.01~10.00	0.01	0.20	×
F3-07	Current loop integral coefficient	1~100	1	10	×
F3-08	Slip compensation coefficient	50~200%	1	100	×
F3-09	Speed feedback filter time constant	1~100 ms	1	6	×
F3-10	Torque limit	0~200%	1	150	×
F3-11	Cross compensation coefficient	0.00 ~ 0.50	0.01	0.20	×

F3-12	Voltage closed loop proportional coefficient	0~ 1.00	0.01	0.20	×
F3-13	Voltage closed loop integral coefficient	0~ 1.00	0.01	0.20	×
F3-14	Magnetic domain control proportional coefficient	10~1000	1	50	×
F3-15	Magnetic domain control integral coefficient	1~500	1	50	×
F3-16	Current given filter time constant	1~100 ms	1	10	×
F3-17	Whether torque control?	0: No torque control 1: In torque control	1	0	☆
F3-18	Torque given	0: Keyboard setting torque F3-19 1: AI1 2: AI2 3: Multi-stage torque 4: RS485 5: HDI	1	0	☆
F3-19	Keyboard setting torque	0.0~200.0%	0.1	50.0	☆
F3-20	Torque given direction	0: positive direction 1: reverse direction	1	0	☆

F3-21	Upper limit frequency setting source selection	0: Upper limit frequency 1: AI1 2: AI2 3: Multi-stage speed 4: RS485 5: HDI	1	0	☆
F3-22	V/F curve selection	0: standard VF curve, V/F = constant 1: square relationship VF curve 2: Custom curve	1	0	×
F3-23	Custom curve F1	0.0 ~ 100.0%	0.1	0.0	×
F3-24	Custom curve V1	0.0 ~ 100.0%	0.1	0.0	×
F3-25	Custom curve F2	0.0 ~ 100.0%	0.1	0.0	×
F3-26	Custom curve V2	0.0 ~ 100.0%	0.1	0.0	×
F3-27	Custom curve F3	0.0 ~ 100.0%	0.1	0.0	×
F3-28	Custom curve V3	0.0 ~ 100.0%	0.1	0.0	×
F3-29	Torque boost	0.0~20.0%	0.1	2.0	×
F3-30	Low frequency oscillation suppression strength	0~1000	1	100	×
F3-31	High frequency oscillation suppression strength	0~1000	1	0	×
F3-32	High and low speed frequency turning point	5.00~50.00 Hz	0.01	20.00	×
F3-33	V/F control slip compensation coefficient	0~200%	1	0	×

### 5.Auxiliary operating parameters (F4 parameters)

Code	Name	Description	Minimum unit	Factory set	Change Limit
F4-00	Positive reversal dead time	0.0~5.0 s	0.1	0.1	☆
F4-01	Jump frequency 1	0.00 ~upper frequency	0.01	0.00	☆
F4-02	Jump frequency 1 amplitude	0.00 ~5.00Hz	0.01	0.00	☆
F4-03	Jump frequency 2	0.00 ~upper frequency	0.01	0.00	☆
F4-04	Jump frequency 2 amplitude	0.00 ~5.00Hz	0.01	0.00	☆
F4-05	Jump frequency 3	0.00 ~upper frequency	0.01	0.00	☆
F4-06	Jump frequency 3 amplitude	0.00 ~5.00Hz	0.01	0.00	☆
F4-07	Jog frequency	0.00~upper frequency	0.01	5.00	☆
F4-08	Jog acceleration time	0.1~6000.0s	0.1	10.0	☆
F4-09	Jog deceleration time	0.1~6000.0s	0.1	10.0	☆
F4-10	Acceleration time 2	0.1~ 6000.0S	0.1	*	☆
F4-11	Deceleration time 2	0.1~ 6000.0S	0.1	*	☆
F4-12	Acceleration time 3	0.1~ 6000.0S	0.1	*	☆
F4-13	Deceleration time 3	0.1~ 6000.0S	0.1	*	☆
F4-14	Acceleration time 4	0.1~ 6000.0S	0.1	*	☆
F4-15	Deceleration time 4	0.1~ 6000.0S	0.1	*	☆
F4-16	Acceleration and deceleration way	0: straight line, 1:S curve	1	0	×
F4-17	Terminal UP/DW rate	0.01~100.00Hz/s	0.01	1.00	☆
F4-18	FDT1 (frequency level) setting	0.00~upper frequency	0.01	50.00	☆

F4-19	FDT1 hysteresis detection value	0.0~100.0%	0.1	5.0	☆
F4-20	FDT2 (frequency level) setting	0.00~upper frequency	0.01	50.00	☆
F4-21	FDT2 hysteresis detection value	0.0~100.0%	0.1	5.0	☆
F4-22	Frequency arrival detection range	0.00~20.00Hz	0.01	1.00	☆
F4-23	PWM modulation method	<p>Unit: Is it overmodulated? 0: no modulation 1: overmodulation</p> <p>Ten digits: modulation method 0: low frequency three-phase modulation, high frequency two-phase modulation 1: Three-phase modulation</p> <p>Hundreds: low frequency processing 0: carrier frequency is greater than 3Khz, low frequency carrier is limited to 3Khz 1: Carrier frequency runs according to the setting</p>	1	0	×
F4-24	Automatic voltage	0: no action	1	0	×

	regulation	1: action 2: no action only when decelerating			
F4-25	Droop control	0.0~10.00Hz	0.01	0.0	×
F4-26	Operation monitoring project selection	0 ~ 3939: The lower two digits and the higher two	1	0100	☆
F4-27	Operation monitoring project selection 2	digits each represent a d parameter, three parameters		0002	☆
F4-28	Operation monitoring project selection 3	can determine six monitoring parameters, and cyclically display as the shift key during operation.		0201	☆
F4-29	Speed display coefficient	0.1~999.9%	0.1	100.0	☆
F4-301	Line speed display coefficient	0.01~99.99	0.01	1.00	☆
F4-31	Multi-function key MF.K setting	0: REV 1: Forward jog 2: Reverse jog 3: Command channel switching	1	0	×

## 6. External input and output terminal definition (F5 parameter)

Code	Name	Description	Minimum unit	Factory set	Change Limit
F5-00	A11 minimum input	0.00~10.00V	0.01	0.00	☆
F5-01	A11 minimum input corresponding setting	-100.00~100.0%	0.1	0.0	☆
F5-02	A11 maximum input	0.00~10.00V	0.01	10.00	☆
F5-03	A11 maximum input	-100.00~100.0%	0.1	100.0	☆

	corresponding setting				
F5-04	AI1 filter time constant	0.01~50.00S	0.01	0.10	☆
F5-05	AI2 minimum input	0.00~10.00V	0.01	0.00	☆
F5-06	AI2 minimum input corresponding setting	-100.00~100.0%	0.1	0.0	☆
F5-07	AI2 maximum input	0.00~10.00V	0.01	10.00	☆
F5-08	AI2 maximum input corresponding setting	-100.00~100.0%	0.1	100.0	☆
F5-09	AI2 filter time constant	0.01~50.00S	0.01	0.10	☆
F5-10	PLUSE Minimum given	0.00~50.00KHz	0.01	0.00	☆
F5-11	PLUSE Minimum given corresponding setting	-100.00~100.0%	0.1	0.0	☆
F5-12	PLUSE Maximum given	0.00~50.00KHz	0.01	50.00	☆
F5-13	PLUSE Maximum given corresponding setting	-100.00~100.0%	0.1	100.0	☆
F5-14	PULSE filter time constant	0.01~50.00S	0.01	0.10	☆
F5-15	External operation command mode selection	0: Two-wire control mode 1 1: two-wire control mode 2 2: Three-wire control mode 1 3: Three-wire control mode 2	1	1	×
F5-16	X1 function selection (0~39)	0: no function 1: FWD forward command		1	×
F5-17	X2 function selection (0~39)	2: REV reverse command 3: External fault input (NO)		2	×
F5-18	X3 function selection( 0~39)	4: DC braking at stop 5: Emergency stop input		7	×

F5-19	X4 function selection (0~39)	6: Fault reset input 7: Multi-speed input 1	8	x
F5-20	X5 function selection (0~39)	8: Multi-speed input 2 9: Multi-speed input 3	9	x
F5-21	X6 function selection (0~40)	10: Multi-speed input 4 11: Three-wire control 12: Terminal UP 13: Terminal DOWN 14: Terminal clear 15: Acceleration and deceleration selection terminal 1 16: acceleration and deceleration selection terminal 2 17: PLC is suspended 18: PLC status reset (method 1, 2) 19: Forward jog 20: Reverse jog 21: swing frequency is suspended 22: swing frequency reset 23: PID is suspended 24: Internal timer allows 25: Internal timer clear 26: Counter trigger input 27: Counter reset (reset to 0) 28: Frequency given A and B switching 29: Frequency given A and A+B switching 30: Frequency given B and A+B	10	x



		switching 31: Acceleration and deceleration speed stop 32: Torque control is prohibited 33: length counter input 34: Length counter clear 35: Command given source is forced to LED keyboard 36: Command is given source forced to terminal 37: Command given source is forced to communication control 38: PID parameter selection 39: External fault normally closed(NC) input 40: Pulse input (only valid for X6)			
F5-27	Y Output selection	0: no function		1	☆
F5-28	Relay 1 output selection	1: running status 2: Fault output 3: Frequency arrival 4: Detection frequency FDT1 arrives 5: Detection frequency FDT2 arrives 6: Running at zero speed 7: Lower limit frequency arrives 8: Upper limit frequency arrives 9: The counter specified value arrives (greater than the specified	1	1	☆

		<p>value, the output is ON)</p> <p>10: The counter final value arrives (equal to the final value, and outputs an ON signal of one count clock cycle)</p> <p>11: Internal timer arrives (output an ON signal in timing unit)</p> <p>12: Run time arrives (more than set time output ON)</p> <p>13: PLC phase operation is completed (output 0.5S ON signal)</p> <p>14: PLC running cycle is completed (output 0.5S ON signal)</p> <p>15: Over-torque warning</p> <p>16: Inverter standby</p> <p>17: Length reached</p> <p>18: Sleeping</p> <p>19: AI1 input exceeds limit</p> <p>20: Module temperature reached</p>			
F5-29	Relay 2 output selection		1	1	☆
F5-34	AO1 Output selection	<p>0: set frequency</p> <p>1: running frequency</p> <p>2: Output current</p> <p>3: Bus voltage</p> <p>4: output voltage</p> <p>5: Output power (100% corresponds to 200% of rated power)</p>	1	0	☆

		6: Torque current 7: AI1 8: AI2 9: Reserved 10: High speed pulse input 11: RS485 setting 12: length 13: count value 14 ~ 20 Reserved			
F5-35	AO1 represents variable 0% corresponding to analog output	0.0~100.0%, when the output is 0~10V, 100.0% corresponds to 10V; when the output is 0~20MA, 100.0% corresponds to 20MA	0.1	0.0	☆
F5-36	AO1 represents variable 100% corresponding to analog output	0.0~100.0%	0.1	100.0	☆
F5-39	AO2 output mode selection	0: Analog 1: HDO pulse output	1	0	☆
F5-40	HDO output frequency upper limit	0.10~50.00KHz	0.01	50.00	☆
F5-41	AO2 output selection	Consistent with AO1 output selection range	1	1	☆
F5-42	AO2 represents variable 0% corresponding to analog output	0.0~100.0% , when the output is 0~10V, 100.0% corresponds to 10V; when the output is pulse, 100.0% corresponds to 50.00KHz	0.1	0.0	☆
F5-43	AO2 represents variable 100% corresponding to analog output	0.0~100.0%	0.	100.0	☆

## 7. PID Parameter (F6 parameter)

Code	Name	Description	Minimum unit	Factory set	Change Limit
F6-00	PID Set channel selection	0: Keyboard potentiometer 1: Fb.01 given      2: F6.01 given 3: AI1    4: AI2    5: RS485 6: PLUSE given 7: multi-speed given	1	0	☆
F6-01	PID given	0~100.0%	0.1	50.0	☆
F6-02	PID feedback channel selection	0: AI1      1: AI2 2: HDI      3: RS485	1	0	☆
F6-03	Adjustment characteristics	0: Positive characteristic 1: Negative characteristic	1	0	☆
F6-04	Proportional gain	0.0~50.0	0.1	5.0	☆
F6-05	Integral time constant	0.1~100.0S	0.1	10.0	☆
F6-06	Differential gain	0.0~5.0	0.1	0.0	☆
F6-08	Preset frequency	0.0 ~ 100.0% Upper limit frequency	0.1	50.0	☆
F6-09	Preset frequency hold time	0.0 ~ 3000.0S	0.1	0.0	☆
F6-10	Feedback disconnection detection threshold	0.0~100.0%	0.1	5.0	☆
F6-11	Feedback disconnection judgment time	0.0~3000.0S, 0.0 No judgment	0.1	0.0	☆
F6-12	PID negative output limit	0~100.0%	0.1	0.0	☆
F6-13	Maximum of twice output deviation	0.00~100.00%	0.01	1.00	☆

## 8. Multi-stage speed and PLC Parameter (F7 parameter)

Code	Name	Description	Minimum unit	Factor y set	Change Limit
F7-00	Programmable multi-speed operation setting	Units: 0: Single run end and shutdown 1: Maintain the final value after single run end 2: Unlimited loop operation Ten: 0: Running time is in seconds 1: Running time is in minutes Hundreds: reserved Thousands: restart mode selection 0: Each start starts from the 0th paragraph 1: Each start starts from the interrupt start frequency	1	2	×
F7-01	Multi-speed frequency 0	0.0 ~ 100.0%	0.1	10.0	☆
F7-02	Multi-speed frequency 1	0.0 ~ 100.0%	0.1	20.0	☆
F7-03	Multi-speed frequency 2	0.0 ~ 100.0%	0.1	30.0	☆
F7-04	Multi-speed frequency 3	0.0 ~ 100.0%	0.1	40.0	☆
F7-05	Multi-speed frequency 4	0.0 ~ 100.0%	0.1	50.0	☆
F7-06	Multi-speed frequency 5	0.0 ~ 100.0%	0.1	70.0	☆
F7-07	Multi-speed frequency 6	0.0 ~ 100.0%	0.1	80.0	☆
F7-08	Multi-speed frequency 7	0.0 ~ 100.0%	0.1	100.0	☆
F7-09	Multi-speed frequency 8	0.0 ~ 100.0%	0.1	10.0	☆
F7-10	Multi-speed frequency 9	0.0 ~ 100.0%	0.1	20.0	☆
F7-11	Multi-speed frequency 10	0.0 ~ 100.0%	0.1	30.0	☆

F7-12	Multi-speed frequency 11	0.0 ~ 100.0%	0.1	40.0	☆
F7-13	Multi-speed frequency 12	0.0 ~ 100.0%	0.1	50.0	☆
F7-14	Multi-speed frequency 13	0.0 ~ 100.0%	0.1	70.0	☆
F7-15	Multi-speed frequency 14	0.0 ~ 100.0%	0.1	80.0	☆
F7-16	Multi-speed frequency 15	0.0 ~ 100.0%	0.1	100.0	☆
F7-17	Phase 0 run time	0.0~3000.0	0.1	10.0	☆
F7-18	Phase 0 running direction and acceleration and deceleration speed	Units: 0: Forward 1: Reverse Ten: 0: Acceleration/deceleration time 1 1: Acceleration/deceleration time 2 2: Acceleration/deceleration time 3 3: Acceleration/deceleration time 4	1	0	☆
F7-19	Phase 1 run time	0.0~3000.0	0.1	10.0	☆
F7-20	Phase 1 running direction and acceleration and deceleration speed	Same as phase 1	1	0	☆
F7-21	Phase 2 run time	0.0~3000.0	0.1	10.0	☆
F7-22	Phase 2 running direction and acceleration and deceleration speed	Same as phase 1	1	0	☆
F7-23	Phase 3 run time	0.0~3000.0	0.1	10.0	☆
F7-24	Phase 3 running direction and acceleration and deceleration speed	Same as phase 1	1	0	☆
F7-25	Phase 4 run time	0.0~3000.0	0.1	10.0	☆
F7-26	Phase 4 running direction and acceleration and deceleration speed	Same as phase 1	1	0	☆

F7-27	Phase 5 run time	0.0~3000.0	0.1	10.0	☆
F7-28	Phase 5 running direction and acceleration and deceleration speed	Same as phase 1	1	0	☆
F7-29	Phase 6 run time	0.0~3000.0	0.1	10.0	☆
F7-30	Phase 6 running direction and acceleration and deceleration speed	Same as phase 1	1	0	☆
F7-31	Phase 7 run time	0.0~3000.0	0.1	10.0	☆
F7-32	Phase 7 running direction and acceleration and deceleration speed	Same as phase 1	1	0	☆
F7-33	Phase 8 run time	0.0~3000.0	0.1	10.0	☆
F7-34	Phase 8 running direction and acceleration and deceleration speed	Same as phase 1	1	0	☆
F7-35	Phase 9 run time	0.0~3000.0	0.1	10.0	☆
F7-36	Phase 9 running direction and acceleration and deceleration speed	Same as phase 1	1	0	☆
F7-37	Phase 10 run time	0.0~3000.0	0.1	10.0	☆
F7-38	Phase 10 running direction and acceleration and deceleration speed	Same as phase 1	1	0	☆
F7-39	Phase 11 run time	0.0~3000.0	0.1	10.0	☆
F7-40	Phase 11 running direction and acceleration and deceleration speed	Same as phase 1	1	0	☆
F7-41	Phase 12 run time	0.0~3000.0	0.1	10.0	☆

F7-42	Phase 12 running direction and acceleration and deceleration speed	Same as phase 1	1	0	☆
F7-43	Phase 13 run time	0.0~3000.0	0.1	10.0	☆
F7-44	Phase 13 running direction and acceleration and deceleration speed	Same as phase 1	1	0	☆
F7-45	Phase 14 run time	0.0~3000.0	0.1	10.0	☆
F7-46	Phase 14 running direction and acceleration and deceleration speed	Same as phase 1	1	0	☆
F7-47	Phase 15 run time	0.0~3000.0	0.1	10.0	☆
F7-48	Phase 15 running direction and acceleration and deceleration speed	Same as phase 1	1	0	☆

## 9. Communication Parameter (F8 parameter)

Code	Name	Description	Minimum unit	Factory set	Change Limit
F8-00	Baud rate selection	0: 300bps    1: 600bps 2: 1200bps    3: 2400bps 4: 4800bps    5: 9600bps 6: 19200bps    7: 38400bps	1	5	☆
F8-01	Data Format	0: no parity    1: odd parity 2: even parity	1	0	☆
F8-02	Address	0~247    0: broadcast address (no return data)	1	1	☆



F8-03	Local response delay	0~100ms	1	5	☆
F8-04	Timeout judgment time	0.0~100.0s; 0.0Communication Timeout,invalid	0.1	0.0	☆
F8-05	Master /slave selection	0: Slave 1: Master	1	0	☆
F8-06	RS485 set frequency proportional coefficient	0~999.9%	0.1	100.0	☆
F8-07	Whether the write operation returns data	0: Return 1: No return	1	0	☆

## 10. Advanced Parameter (F9 parameter)

Code	Name	Description	Minimum unit	Factory set	Change Limit
F9-00	Swing frequency amplitude	0.0~100.0%	0.1	0.0	☆
F9-01	Kick frequency amplitude	0.0~50.0%	0.1	0.0	☆
F9-02	Triangle wave rise time	0.1~3600.0S	0.1	5.0	☆
F9-03	Triangle wave fall time	0.1~3600.0S	0.1	5.0	☆
F9-04	Counter specified value	0~65535	1	1000	☆
F9-05	Counter final value	0~65535	1	2000	☆
F9-06	Set length	0~65535M	1	1000	☆
F9-07	Pulse number per meter	0.1~6553.5	0.1	100.0	☆
F9-08	Internal timer timing unit	0.01~99.99S	0.01	1.00	☆
F9-09	Internal timer period	1~65535	1	10	☆
F9-10	Set running time	0~65535H	1	65535	☆
F9-10 1	X1 turn-on delay time	0.0~3600.0S	0.1	0.0	☆
F9-12	X1 turn-off delay time	0.0~3600.0S	0.1	0.0	☆
F9-13	X2 turn-on delay time	0.0~3600.0S	0.1	0.0	☆
F9-14	X2 turn-off delay time	0.0~3600.0S	0.1	0.0	☆
F9-15	X3 turn-on delay time	0.0~3600.0S	0.1	0.0	☆

F9-16	X3 turn-off delay time	0.0~3600.0S	0.1	0.0	☆
F9-17	Y1 output delay time	0.0~3600.0S	0.1	0.0	☆
F9-18	Relay 1 output delay time	0.0~3600.0S	0.1	0.0	☆
F9-19	Relay 2 output delay time	0.0~3600.0S	0.1	0.0	☆

## 11. Enhance control parameters (FA parameters)

Code	Name	Description	Minimum unit	Factor set	Change Limit
FA-00	Whether VF separation?	0: no separation 1: semi-separation 2: full separation	1	0	×
FA-01	Voltage source selection	0: FA-02 1: AI1 2: AI2 3: Keyboard potentiometer 4: PID 5: AI1+PID	1	0	☆
FA-02	Keyboard setting voltage given	0~100.0%	0.1	0.0	☆
FA-03	Voltage acceleration and deceleration time	0.1~3600.0S	0.1	0.1	☆
FA-05	Vector 2 magnetic domain setting	80.00~100.00%	0.01	90.00	×
FA-06	UP/DW setting whether to stop and clear	0: Not clear 1:Clear	1	0	☆

## 12. Enhance PID Parameter (Fb parameter)

Code	Name	Description	Minimum unit	Factor set	Change Limit
Fb-00	Remote pressure gauge range	0.001~60.000MPA	0.001	1.600	☆

Fb-01	Keyboard pressure setting	0.001~20.000MPA	0.001	0.500	☆
Fb-02	Modify the keyboard settings whether to store automatically	0:not store 1: automatic store	1	1	×
Fb-03	Sleep frequency	0.00~600.00Hz	0.01	0.00	☆
Fb-04	Sleep delay time	0.0~3000.0S	0.1	60.0S	☆
Fb-05	Wake pressure	0~100.0%	0.1	0.0	☆
Fb-06	Wake delay time	0.0~60.0S	0.1	0.5	☆
Fb-07	Under load protection value	0.0~100.0% 0.0: No under load protection	0.1	0.0	×
Fb-08	Allowable under load time	5.0~600.0S	0.1	20.0	×
Fb-09	PID parameter selection	0~3	1	0	×
Fb-10	Proportional gain 2	0.0~50.0	0.1	5.0	☆
Fb-11	Integration time constant 2	0.1~100.0S	0.1	10.0	☆
Fb-12	Differential gain 2	0.0~5.0	0.1	0.0	☆
Fb-13	PID parameter switching deviation 1	0.0~100.0%	0.1	20.0	☆
Fb-14	PID parameter switching deviation 2	0.0~100.0%	0.1	80.0	☆
Fb-15	PID parameter switching deviation1	0.0~100.0%	0.1	20.0	☆
Fb-16	PID parameter switching deviation 2	0.0~100.0%	0.1	80.0	☆

### 13. Protection parameter (Fd parameter)

Code	Name	Description	Minimum unit	Factory set	Change Limit
Fd-00	Current limit value	100.0~200.0%	0.1	*	☆
Fd-01	Current too large, frequency	1.0~200.0S	0.1	5.0	☆

	fall time				
Fd-02	Overvoltage limit value	110.0~145.0%	1	130.0	☆
Fd-03	Overvoltage suppression gain	0~10	1	2	☆
Fd-04	Phase loss protection	Unit: Input phase loss 0: no protection 1: protection Ten digits: output phase loss 0: no protection 1: protection	1	11	☆
Fd-05	Motor overload protection	20.0~100.0%	0.1	100.0%	☆
Fd-06	Over torque warning value	20.0~200.0%	0.1	*	☆
Fd-07	Over torque detection time	0.0~60.0S	0.1	0.1	☆
Fd-08	Number of Fault automatic resets	0~5	1	0	☆
Fd-09	Fault Automatic reset interval time	0.1~600.0S	0.1	1.0	☆
Fd-10	Relay fault output during reset	0: No output 1: Output	1	0	☆
Fd-11	AI1 input voltage lower limit	0.00~10.00V	0.01	2.00	☆
Fd-12	AI1 input voltage upper limit	0.00~11.00V	0.01	8.00	☆
Fd-13	Module temperature reached	25.0~90.0℃	0.1	70.0	☆
Fd-14	First two fault	0~30	1	0	×
Fd-15	Previous fault	0~30	1	0	×
Fd-16	Current fault	0~30	1	0	×
Fd-17	Output frequency at current fault	0 ~Upper limit frequency	0.01	0.00	×
Fd-18	Output current at current fault	0 ~ 3000.0A	0.1	0.0	×

Fd-19	DC bus voltage at current fault	0 ~ 800V	1	0	×
-------	------------------------------------	----------	---	---	---

#### 14. Status monitoring parameter list

Monitor Code	Content	Minimum Unit
d-00	Current output frequency of the inverter	0.01Hz
d-01	Current output voltage of the inverter	1V
d-02	Current output current of the inverter	0.1A
d-03	Current set frequency of the inverter	0.01Hz
d-04	current output frequency 2 of the inverter	0.01Hz
d-05	DC bus voltage	1V
d-06	Module temperature	0.1℃
d-07	PID setting value	0.1%
d-08	PID feedback value	0.1%
d-09	Rotating speed	rmp
d-10	Running line speed	0.01*
d-11	External pulse input	0.01KHz
d-12	RS485 setting	
d-13	Reserved	
d-14	AI1	0.1V
d-15	AI2	0.1V
d-16	DI terminal status	
d-17	DO terminal status	
d-18	Single continuous running time	1H
d-19	Running time accumulation	1H
d-20	External pulse count value	
d-21	Internal timer count value	
d-22	Actual length	m
d-23	Set pressure	MPa
d-24	Actual pressure	MPa
d-37	Inverter rated voltage	1V
d-38	Inverter rated current	0.1A
d-39	Product version number	

DI Terminal status description: The last three digits of the five digits display the digital tube input status.

DO Terminal status description: Y is the lowest bit, relay 1 output is the second, relay 2 output is the highest digit binary number, converted into decimal display.

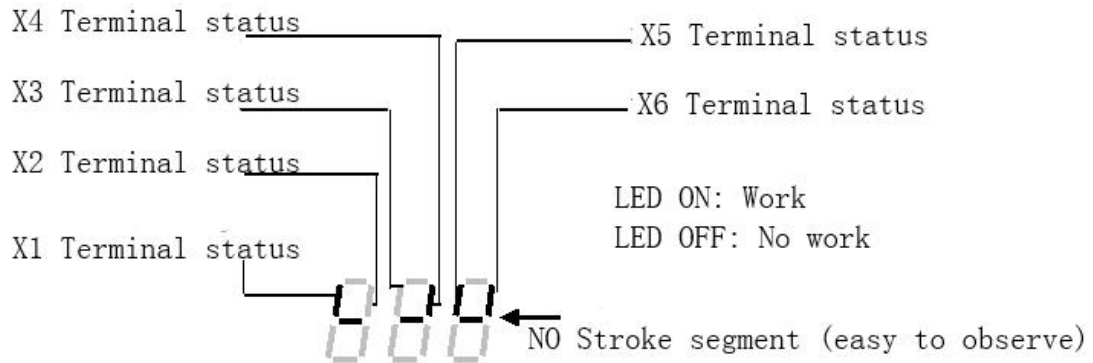

## Chapter 5 Fault treatment and solution

CM520 all possible faults are summarized in Table 5-1. If inverter has fault, customer could process it according to the instructions in table before seeking service and record the processing and phenomena in detail. If the fault still cannot be solved, you can seek support from the manufacturer or local office.

Table 5-1

Fault Code	Fault description	Possible reason	Solution	SN
E. SC	Output short circuit fault	1. Output is short-circuit or is grounded 2. The load is too heavy	1. Check wiring 2. Ask help from manufacturers	1
E. OC1	Overcurrent in acceleration	1. The acceleration time is too short 2. The torque boost is too high or the V/F curve is not suitable	1. Increase the acceleration time 2. Reduce torque boost voltage and adjust V/F curve	2
E. OC2	Overcurrent in deceleration	Deceleration time is too short	Increase deceleration time	3
E. OC3	Overcurrent in operation	Load mutation	Reduce load fluctuations	4
E. OC4	Software overcurrent	Same as E.OC1, E.OC2, E.OC3	Same as E.OC1, E.OC2, E.OC3	5
E.232.	Internal downlink communication fault	Hardware problem	Ask help from manufacturers	6
E. Gnd	Ground Fault	1. Motor or inverter output is grounded 2. Inverter input and output wire contact	1. Check wiring 2. Check if the motor is aged?	7
E. OU1	Overpressure in acceleration	1. The input voltage is too high 2. Power is frequently turned on and off	Check the power supply voltage	8
E. OU2	Overpressure in deceleration	1. Deceleration time is too short 2. Input voltage is abnormal	1. Increase the deceleration time 2. Check the power supply voltage 3. Install or re-select the braking	9

			resistor	
E.OU3	Overpressure in operation	1.Power supply voltage is abnormal. 2. Energy feedback load	1.Check the power supply voltage 2. Install or re-select the braking resistor	10
E. UL	Underload	1. Inverter output line is weak connected 2. Inverter load disappears	1. Check wiring 2. Check the inverter load	14
E.OL1	Inverter overload	1.The load is too heavy 2.The acceleration time is too short 3.Torque boost is too high or V/F curve is not suitable 4.The grid voltage is too low	1. Reduce the load or replace it with a larger capacity inverter 2. Increase the acceleration time 3. Reduce torque boost voltage and adjust V/F curve 4. Check the grid voltage	15
<b>Fault Code</b>	<b>Fault description</b>	<b>Possible reason</b>	<b>Solution</b>	<b>SN</b>
E.OL2	Motor overload	1. The load is too heavy 2. The acceleration time is too short 3. The protection coefficient setting is too small 4. Torque boost is too high or V/F curve is not suitable	1.Reduce the load 2.Increase the acceleration time 3.Increase the motor overload protection coefficient 4.Reduce torque boost voltage and adjust V/F curve	16
E.CUr	Current detection error	1. Current detection device or circuit is damaged 2. the auxiliary power supply fault	Ask help from manufacturers	17
E. LU	Under voltage in operation	1. The power supply voltage is abnormal. 2. There is a large load start in the grid	1. Check the power supply voltage 2. Separate power supply	18
E.EF1	NO terminal external device fault	The external device fault input terminal of the inverter has signal input	Check signal source and related equipment	19
E.EF2	NC terminal external device fault	The external device fault input terminal of the inverter has signal input	Check signal source and related equipment	20
E.OH	Inverter overheating	1. Air duct obstruction 2. The Environment temperature is too high 3. Fan is damaged	1. Clean the air duct or improve ventilation 2. Reduce the carrier frequency 3. Replace the fan	21



E.SP1	Input phase loss	1. Input voltage phase loss 2. Input voltage is too low	1. Check the input wiring 2. Check if the grid is out of phase?	22
E.SP0	Output phase loss	Poor wiring or disconnection between inverter and motor	Check wiring	23
E.EEP	Memory fault	hardware malfunction	Ask help from manufacturers	24
E.End	Running time reach	Internal settings allow runtime reached	Ask help from manufacturers	25
E. PID	PID feedback fault	1. PID feedback signal line is disconnected 2. Sensor used to detect the transmission of feedback signals fault 3. The feedback signal does not match the setting.	1. Check the feedback channel 2. Check if the sensor is faulty 3. Verify that the feedback signal meets the set requirements	26
E.485	RS485 communication fault	Error in sending and receiving data during serial communication	1. Check wiring 2. Ask help from manufacturers	27
E.doG	interference	Malfunction due to ambient electromagnetic interference	Add an absorbing circuit to the interference source around the inverter	28
E.232	Internal uplink communication fault	hardware malfunction	Ask help from manufacturers	29

This series of inverters records the fault code that occurred in the last 3 times and the inverter output parameters in the last fault. Querying these information will help user to find the cause of the fault.

## Appendix 1 RS485 Communication Protocol

CM520 series inverter provides RS485 communication interface, adopts international common ModBus communication protocol for master-slave control, user can realize centralized monitoring through PC/PLC (set inverter control command, running frequency, related function code modification, read operating status of the inverter to suit the specific application requirements.

### 1. Protocol Content

The serial communication protocol defines the information content and usage format transmitted in serial communication. includes: host polling and broadcast frame, slave response frame format; host organization frame content includes: slave address (or broadcast address), execution commands, data and error check. The slaves also use the same structure, including: action confirmation, return data and error check. If an error occurs while accepting a frame from a slave, or if the action requested by the host cannot be completed, it will organize a fault frame as a response to the host.

### 2. Application method

CM520 serial inverter is with “single-master /multi-slave control” control network by RS232/RS485 bus.

### 3. Bus structure

#### (1) Method of interface

RS485 hardware interface

#### (2) transfer method

Asynchronization serial, half duplex transmission. The host and slave just send the data by only one, the other one accept the data at the same time. In the process of serial asynchronous communication, data is transmitted by each frame.

#### (3) Topological structure

Single host and sever slave system. The setting range of slave address is 1~247,

0 is broadcast communication address. The net slave address is unique ,which is the basis for guaranteed ModBus serial communication.

#### 4. Protocol introduction

CM520 series inverter protocol is an asynchronous serial master-slave communication protocol. Only one device (host) in the network can establish a protocol (called “query/command.” Other devices (slave) can only provide data response according to data provided, or make the corresponding action according to the command/query of the host.

The host here refers to a personal computer (PC), a industrial computer, and a programmable controller (PLC).

The slave refers to a frequency converter or other control device with the same communication protocol.

The host can communicate with a single slave and broadcast information to all slaves. For a host query/command that is accessed separately, the slave returns a message (called a response); for broadcast messages sent by the host, the slave does not need to respond to the host.

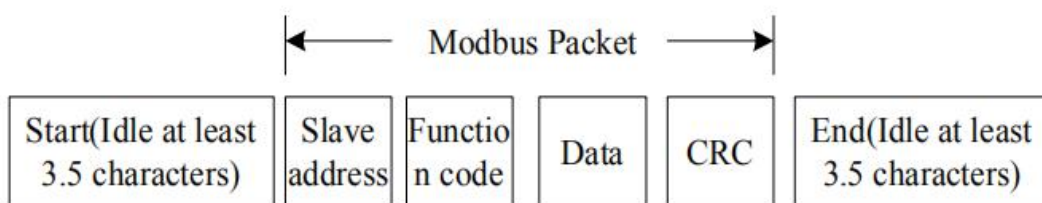

#### 5. Communication frame structure

ModBus protocol communication of the CM520 series inverter data format is RTU (Remote Terminal Unit) mode. The new data frame is always silenced with a transmission time of at least 3.5 bytes as a start. On a network that calculates the transmission rate at baud rate, 3.5 bytes of transmission time can be easily grasped. The data domain that are transmitted next are: slave address, operation command code, data, and CRC check word. Each

domain transmission byte is hexadecimal data 0...9, A...F. Even during silent periods, network devices constantly monitor the activity of the communication bus. When the first domain information (address information) is received, each network device confirms the byte. As the transmission of the last byte is completed,

there is another 3.5-byte transmission time to indicate the frame end, after this, new frame transmission will start .

Once frame information must be transmitted in a continuous stream. If there is more than 1.5 bytes interval before the end of the entire frame transmission, the receiving device will clear these incomplete information and mistakenly think that the next byte is the address domain part of new frame. Similarly, if the interval between the start of a new frame and the previous frame is less than 3.5 bytes, the receiving device will think it to be the continuation of the previous frame, due to these frame confusion, the final CRC check value is incorrect, causing communication fault.

### RTU frame standard structure

Frame header	3.5 bytes transmission time's silence
Slave address domain ADDR	0~247(0: broadcast address)
Execute command CMD	03H: Read slave parameters 06H: Write slave parameters
Data domain DATA(N-1) ... DATA(0)	2*N bytes data, this part is the main content of communication, and also the core of data exchange in communication
CRC CHK low bit	Check code: CRC check value
CRC CHK high bit	
End of frame	3.5 bytes transmission time's silence

## 6. Command code and communication data description

### 6.1 Command code

Command code: 03H (0000 0011), Read N words (Word) (maximum can read 5 words constantly);

For example: If the slave address is 01H inverter, if the host(master) want to read F0-04 Parameter value, then frame structure should be described as below:

#### RTU Master command information

Frame header	3.5 bytes transmission time's silence
Slave address domain ADDR	01H
Execute command CMD	03H
Start address high bit	F0H
Start address low bit	04H
Data numbers high bit	00H
Data numbers low bit	01H
CRC CHK low bit	F6H
CRC CHK high bit	CBH
End of frame	3.5 bytes transmission time's silence

#### RTU Slave command information

Frame header	3.5 bytes transmission time's silence
Slave address domain ADDR	01H
Execute command CMD	03H
Number of bytes of data read	02H
F0-04 parameter value high bit	00H
F0-04 parameter value low bit	01H
CRC CHK low bit	79H
CRC CHK high bit	84H
End of frame	3.5 bytes transmission time's silence

Command code:06H (0000 0110) ,write a word to a parameter address. For example, write 20.00 to the F0-07 parameter of the inverter which slave address is 01H (actually write data 2000, corresponding to hexadecimal data is 7D0H).

### RTU Master command information

Frame header	3.5 bytes transmission time's silence
Slave address domain ADDR	01H
Execute command CMD	06H
Start address high bit	F0H
Start address low bit	07H
Data numbers high bit	07H
Data numbers low bit	D0H
CRC CHK low bit	08H
CRC CHK high bit	A7H
End of frame	3.5 bytes transmission time's silence

### RTU Slave command information

Frame header	3.5 bytes transmission time's silence
Slave address domain ADDR	01H
Execute command CMD	06H
Start address high bit	F0H
Start address low bit	07H
Data numbers high bit	07H
Data numbers low bit	D0H
CRC CHK low bit	08H
CRC CHK high bit	A7H
End of frame	3.5 bytes transmission time's silence

There are two ways to indicate the starting address, such as: FX.YZ parameter, which can be expressed as FX YZ (high position first, low position

after), or 0X YZ. When the operation command is 06, the upper computer adopts the first address representation mode, and the written data is stored in the E2PROM. The second address representation mode is used to change only the data in the RAM, thereby reducing the number of operations of the E2PROM. The host computer may generate an exception regardless of whether it is a read command (03) or a write command (06). At this time, the inverter will return an error code.

### RTU slave returns error message

Frame header	Silence of 3.5 bytes of transmission time
Slave address field ADDR	XX
Abnormal prompt	86H
Exception code high	00
Exception code low	0X
CRC CHK Low position	XX
CRC CHK High position	XX
End of frame	Silence of 3.5 bytes of transmission time

The meaning of the exception code:

01H: Invalid command

02H: Invalid address

03H: Invalid data

04H: CRC error

05H: Parameters cannot be modified

## 6.2 Communication frame check mode

The error check mode of the frame mainly includes two parts of the check, that is, the bit check of the byte (odd/even check) and the entire data check of the frame (CRC check).

### 6.2.1 Byte check

Users can choose different bit verification methods as needed, or they can

choose no parity. The meaning of odd parity: an odd parity bit is added before data transmission to indicate whether the number of "1" in the transmitted data is odd or even. When it is odd, the check position is "0", otherwise it is set. "1" to keep the parity of the data unchanged.

The meaning of even parity: an even parity bit is added before data transmission to indicate whether the number of "1" in the transmitted data is odd or even. When it is even, the check position is "0", otherwise it is set. "1" to keep the parity of the data unchanged. For example, it is necessary to transmit "11001110", the data contains 5 "1", if even parity is used, its even parity bit is "1", if odd parity is used, its odd parity bit is "0", and the data is transmitted. When the parity bit is calculated and placed at the check digit of the frame, the receiving device also performs parity check. If the parity of the accepted data is found to be inconsistent with the preset, it is considered that the communication has an error.

### **6.2.2 CRC check method---CRC(Cyclical Redundancy Check)**

Using the RTU format, the frame includes a frame error detection field calculated based on the CRC method. The CRC field detects the contents of the entire frame. The CRC field is two bytes and contains 16 bits of binary. It is calculated by the transmission device and added to the frame. The receiving device recalculates the CRC of the received frame and compares it with the value in the received CRC field. If they are not equal, the transmission has an error.

The CRC is first stored in 0XFFFF and then a procedure is called to process the bytes in the frame with the values in the current register. Only 8Bit data in each byte is valid for the CRC, and the start and stop bits as well as the parity bit are invalid.

During the CRC generation process, each 8-bit byte is individually different from the register contents (XOR), and the result moves to the least significant bit direction, and the most significant bit is padded with 0s. The



LSB is extracted and detected. If the LSB is 1, the register is individually or different from the preset value. If the LSB is 0, it is not performed. The entire process is repeated 8 times. After the last bit (bit 8) is completed, the next octet is individually different from the contents of the register. The value in the final register is the CRC value after all the bytes in the frame have been executed.

The calculation method of CRC adopts the international standard CRC check rule. When editing the CRC algorithm, the user can refer to the relevant CRC standard algorithm to write a CRC calculation program that truly meets the requirements.

Now provide a simple function of CRC calculation for user reference (programming in C language):

```
unsigned int crc_cal_value(unsigned char *data_value, unsigned char
data_length)
{
    int i;
    unsigned int crc_value=0xffff;
    while(data_length--)
    {
        crc_value^=*data_value++;
        for(i=0;i<8;i++)
        {
            if(crc_value&0x0001)crc_value=(crc_value>>1)^0xa001;
            else  crc_value=crc_value>>1;
        }
    }
    return(crc_value);
}
```

In the ladder logic, CKSM calculates the CRC value according to the

frame content, and uses the look-up table method to calculate. This method is simple and fast, but the ROM space used by the program is large. If there is a requirement for program space, please use it cautiously.

### 6.3 Communication address definition

This part is the address definition of the communication data, which is used to control the operation of the inverter, obtain the status information of the inverter and the related function parameter settings of the inverter.

The address of the function parameter has been described above, such as: FX.YZ parameter, which can be expressed as FX YZ (high position first, low position after), or 0X YZ. When the operation command is 06, the upper computer adopts the first address representation mode, and the written data is stored in the E2PROM. The second address representation mode is used to change only the data in the RAM, thereby reducing the number of operations of the E2PROM. Address description for other features.

Function Description	Address definition	Data meaning description	R/W characteristic
Monitoring parameter	1000H	d-00	R
	1001H	d-01	
	.	.	
	.	.	
	1015H	d-21	
Run command	2000H	0000H: Downtime 0001H: Forward running 0002H: Reverse run 0003H: Fault reset	W
	3000H	0001H: Forward running 0002H: Reverse run	

Operating status		0003H: Standby 0004H: In failure	R
Frequency given	4000H	The percentage of the upper limit frequency, the upper limit frequency corresponds to 10000	W
Inverter fault	5000H	Return the fault number (see Chapter 5)	R

## Appendix 2 Function Description

### 1. Basic operating parameters (F0 parameters)

F0-00 Model selection	Predetermined area: 0, 1
-----------------------	--------------------------

**0: G Model, Suitable for constant torque loads**

**1: P Model, Suitable for variable torque loads (fan, pump load)**

The CM520 series inverter adopts the G/P unity mode, that is, the constant torque load (G type) adapter motor is smaller than the one used for the fan and pump type load (P type).

F0-01 Control way	Predetermined area: 0~3
-------------------	-------------------------

**0: V/F control**

Applicable to most applications, it is suitable for the case where one inverter drives one motor, and it is also suitable for the case where one inverter drives multiple motors (multiple motors have the same working condition), especially for open loops beyond the fundamental frequency. Control the occasion.

**1: Vectorization VF control**

The vectorization processing of the ordinary VF control improves the stability of the control and the low-frequency torque, and is insensitive to the motor parameters.

**2: Non-inductive vector control 1**

Using a unique vector control idea, vector control is more versatile and has good steady-state performance, but the dynamic index is worse than vector control 2 and is not sensitive to motor parameters.

**3: Non-inductive vector control 2**

<b>F0-02 Operation command source selection</b> setting range: 0 ~ 2
---

The rotor field oriented vector control has high control dynamic and static performance and is sensitive to motor parameters.

**0: Run command is controlled by LED keyboard****1: Running command is controlled by terminal**

F0-03 Main frequency setting source selection A setting range: 0 ~ 11
---

**2: Operation command communication control****0: Keyboard potentiometer given**

Set the operating frequency by the potentiometer on the operation panel

**1: The keyboard rises and the down button determines the running frequency.**

By operating the up and down buttons on the keyboard, you can change the frequency value in the F0-07 parameter and set the operating frequency.

**2: AI1 (0-10V)**

Set the operating frequency from the external analog voltage input terminal

AI1 (0 to 10V)

**3: AI2 (0-10V/0~20mA)**

Set the operating frequency from the external analog voltage input terminal

AI2 (0 to 10V/0 to 20mA)

**4: Keep****5: PID Closed loop given frequency**

The operating frequency is set by the output of the PID regulator.

**6: Multi-speed control**

The external terminals X1 to X6 can be selected as the multi-speed terminal according to F5-16 to F5-21. Select the corresponding set frequency (F7-01~F7-16) by the status of the multi-speed terminal

**7: PLC given**

When the frequency source is a simple PLC, you need to set the F7 group "multi-speed and PLC" parameters to determine the given frequency of each phase of operation. For the PLC running settings, please refer to the F7 group function code description.

**8: UP/DW Terminal given**

The running frequency is set by the external control terminal UP/DW (UP and DW control terminals are selected by parameters F5-16 to F5-21). When UP-COM is closed, the running frequency increases, and when DW-COM is closed, the running frequency decreases. When the UP and DW are simultaneously closed or disconnected from the COM terminal, the operating frequency remains unchanged. The rising and falling of the set frequency is performed by the acceleration/deceleration time set by F4-17.

### **9: Communication control**

The frequency command of the host computer is received through the RS485 interface. This mode should be selected when the host computer sets the frequency or the unit is set to the slave in the linkage control.

### **10: Keep**

### **11: High speed pulse given**

The running frequency is set by the external pulse signal, and the pulse input terminal is selected by parameter F5-21. (X6)

**F0-04 Auxiliary frequency setting source selection B**  
**Setting range: 0 ~ 5**

### **0: Keyboard potentiometer given**

**1: AI1 (0-10V)**

**2: AI2 (0-10V/0~20mA)**

**3: F0-07**

**4: High speed pulse given**

**5: Multi-speed**

**F0-05 Auxiliary frequency setting source selection B**  
**Setting range: 0 ~ 1**

### **0: Frequency cap**

#### **1: Main frequency given A**

The set value obtained by the auxiliary frequency setting source is 0 to 100.0%, and different reference values are selected, and the actual set frequency is also different.

<b>F0-06 Auxiliary frequency setting source selection</b>	<b>Setting range: 0 ~3</b>
---	----------------------------

**0: A frequency given**

When the frequency is given as A, the frequency can be switched between A and B through the function of terminal No. 28; the frequency can be switched between A and A+B through the function of terminal No. 29;

**1: B frequency given**

When the frequency is given as B, the frequency reference can be switched from B to A+B by function No. 30.

**2: A+B****3: MAX (A, B)****4: Min (A, B)****5: A-B**

<b>F0-07 Panel digital setting frequency</b> Setting range: 0 .00~Upper
--

In the status monitoring mode, press the up, down key or key on the operation panel to directly modify this parameter.

<b>F0-08 Upper limit frequency</b> Setting range: 5 .00~ 650.00Hz
<b>F0-09 Lower limit frequency</b> Setting range: 0 .00~F0-08

The upper limit frequency is the upper limit of the inverter output frequency, the external analog reference, multi-speed and PLC set frequency source, the percentage is given, and the reference value is the upper limit frequency.

<b>F0-10 Lower limit frequency operation mode</b> Setting range: 0~2
--

**0: When the set frequency is lower than the lower limit frequency, press the limit frequency to run**

**1: when the set frequency is lower than the lower limit frequency, it will out of service** After the stop, if the terminal switch control or RS485 control, the start command is often, you need to confirm the stop command, you can start again; if the keyboard control or terminal pulse control, only the start trigger signal will start again. If the terminal command mode, only the terminal

command is invalid, it can be used again if it is valid.

**2: Sleep standby** When the set frequency is lower than the lower limit frequency, the output is blocked, the running command is not canceled, and the setting is started when the set frequency is greater than the lower limit frequency.

F0-11 Sleep wakeup time	setting range: 0 .00~ 3000.0 second
-------------------------	-------------------------------------

When the inverter is in the sleep state, the sleep state will be exited only when the set frequency is greater than the time set by the lower limit frequency for F0.11.

F0-12 acceleration time	setting range: 0 .00~ 6000.0S
F0-13 deceleration time	setting range: 0 .00~ 6000.0S

The acceleration time refers to the time required for the output frequency to accelerate from 0 Hz to the rated frequency value. The deceleration time refers to the time required for the output frequency to decelerate from the rated set reference frequency value to 0 Hz.

F0-14 Carrier frequency	Setting range: 1 ~ 10KHz
-------------------------	--------------------------

The carrier frequency primarily affects the audible noise and thermal effects in operation. When the ambient temperature is high and the motor load is heavy, the carrier frequency should be appropriately reduced to improve the thermal characteristics of the inverter.

F0-15 Steering control	Predetermined area: 0, 1, 2
------------------------	-----------------------------

This parameter is used to change the current output phase sequence of the inverter, thus changing the running direction of the motor.

**0: Consistent with the set direction**



**1: Contrary to the setting direction**

Select this mode, the actual output phase sequence of the inverter is opposite to the setting.

**2: Reverse prevention** The drive will ignore the steering command and only operate in the forward direction.

F0-17 Parameter initialization	Setting range: 0~9999
--------------------------------	-----------------------

Change the parameters of the inverter to the factory values.

**0: No action**

**11: Restore parameters to their initial values by model**

**22: Clear fault record**

Note: Please set the model (F0-00) according to the actual situation before initialization.

This parameter is a key parameter and cannot be changed by the user.

F0-18 Parameter protection	Setting Range: 0, 1
----------------------------	---------------------

**0: None protection**

**1: Protection** All parameters cannot be changed. However, F0-07 can be changed by the up and down keys in the monitoring state.

**1. Start and stop parameters (F1)**

F1-00 Startup mode
--------------------

**0: Start by start frequency** After receiving the running command, the inverter will run according to the set starting frequency (F1-01). After the starting frequency duration (F1-02), press the acceleration and deceleration time to the set frequency.

**1: Brake and start again** The inverter first applies a certain DC braking current to the load motor (ie, the electromagnetic brake is defined in parameters F1-03 and F1-04), and then starts again. It is suitable for small

inertia with forward or reverse rotation in the stop state load.

**2: Speed tracking restart** The inverter first detects the speed of the motor, and then uses the detected speed as the starting point to run to the set frequency according to the acceleration and deceleration time.

F1-01 Starting frequency	Setting range: 0.0 ~ 10.0Hz
F1-02 Start frequency duration	Setting range: 0.0 ~ 20.0S

Properly set the starting frequency to improve the starting torque characteristics, but if the set value is too large, an overcurrent fault sometimes occurs.

The starting frequency duration refers to the duration of running at the starting frequency. If the set frequency is lower than the starting frequency, the operating frequency is first started. After the starting frequency duration is reached, the set deceleration time is decreased to the set frequency.

F1-03 Start DC braking current	Setting Range: 0 ~ 150%
F1-04 Start DC braking duration	Setting Range: 0.0 ~ 30.0S

When the start mode is set to the brake restart mode, the DC brake function is enabled.

F1-03 is the DC braking current at start-up (% of rated current), F1-04 is the duration, DC braking output DC current. The DC braking mode is started as shown in Figure 1.

Figure 1 DC braking mode start

F1-05 Stop mode	Setting Range: 0, 1
-----------------	---------------------

**0: Deceleration mode** After receiving the stop signal, it will decelerate to stop according to the set deceleration time.

**1: Free stop** After receiving the stop signal, the output is blocked and the motor runs freely and stops.

F1-06 Stop DC braking start frequency	Setting Range: 0.00 ~ 50.00Hz
F1-07 DC braking current at stop	Setting Range: 0 ~ 150%
F1-08 Stop DC braking action time	Setting range: 0.0 ~ 60.0S

These three parameters are used to define the DC braking function of the inverter during shutdown. When the inverter is in the process of stopping, when the output frequency of the inverter is lower than the DC braking start frequency, the inverter will start the DC braking function.

The DC braking action time is the duration of DC braking. When this parameter is set to 0, the DC braking function at shutdown is turned off. When DC braking, the inverter outputs DC current. The DC braking function provides zero speed torque, which is usually used to improve the stopping accuracy, but it cannot be used for deceleration braking in normal operation.

F1-10 Speed tracking wait time	Setting Range: 0.0~10.0s
F1-11 Speed tracking search time	Setting Range: 6.0 ~ 1000.0S
F1-12 speed tracking completion condition	Setting range: 1.00~50.00%

Since there is residual magnetism inside the motor, when the motor just stops, the speed tracking is performed immediately. At the start, the inverter may over-current. Appropriately increasing F1-10 will effectively reduce the probability of overcurrent.

According to the current to determine the motor speed search time, the shorter the setting, the faster the search, but it is easy to report the flow, generally according to the factory value.

According to the current to determine the motor speed, the motor current is less than F1-12 as the completion condition. The larger the F1-12 is, the easier it is to search for the speed, but the speed deviation is also larger, generally according to the factory value.

F1-13 Brake brake starting voltage	Setting Range: 105.0~140.0%
F1-14 Brake brake termination voltage	Setting Range: 105.0~150.0%

When the DC bus voltage reaches the starting voltage, the brake PWM signal begins to output. As the bus voltage increases, the duty cycle gradually increases from 0% to 100% when the voltage is terminated. If the brake end voltage setting is less than the starting voltage, the PWM will not be output.

F1-15 Power-on terminal running command detection
Setting Range: 0, 1

#### **0: Power-on running command is invalid**

After the inverter is powered on, if the running command source selection is terminal reference, even if the terminal running command is valid, the inverter will not respond, preventing the inverter from starting suddenly and causing damage. For the system to work effectively, it is necessary to invalidate the terminal and then valid. Preventing a power-on, the inverter will run immediately and cause injury to personnel or equipment.

#### **1: Power-on running command is valid**

After the inverter is powered on, the terminal running command is valid and the inverter runs.

F1-16 Stop speed	Setting Range: 0.00~100.00%
F1-17 Stop speed detection mode	Setting Range: 0, 1

When there is a stop command, the inverter output frequency (speed) is lower than the F1-16 setting, and the inverter blocks the output and is in the stop state.

#### **Stop speed detection mode:**

#### **0: Check out by speed setting**

**1: Check by actual speed (for vector control)****1. Motor parameters (F2 parameters)**

F2-00 Motor type	Setting Range: 0, 1
------------------	---------------------

0: Asynchronous motor

1: Permanent magnet synchronous motor

F2-01 Motor rated voltage	Predetermined area: 1~7000V
F2-02 Motor rated frequency	Setting Range: 15.00~120.00Hz
F2-03 Rated current	Setting Range: 0.1~1000.0 A
F2-04 Rated slip frequency	Setting Range: 0.00~5.00Hz
F2-05 Number of pole pairs	Setting Range: 1~50

Set according to the nameplate of the drive motor.

F2-06 No-load current	Setting Range: 10.0~ 70.0%
F2-07 Stator resistance	Setting Range: 0.00~50.00%
F2-08 Rotor resistance	Setting Range: 0.00~50.00%
F2-09 Leakage resistance	Setting Range: 0.00~50.00%
F2-10 Motor parameter self-tuning	Setting Range: 0, 1, 2

After the motor auto tuning is completed normally, the set values of F2-06~F2-9 are automatically updated. The motor parameters are relative to the set motor nominal parameters:

F2-06 No-load current, after dividing the actual no-load current of the motor by the rated current of the motor, multiply by 100%.

F2-07 stator resistance is the value obtained by multiplying the actual stator resistance by the rated stator current, dividing by the rated voltage of the motor, and multiplying by 1.732. F2-08 is the same.

F2-09 leakage inductance, leakage inductance as a percentage of mutual inductance.

If the motor cannot be tuned in the field, it can be manually entered with reference to the known parameters of the same type of motor.

Tip: Before tuning, you must set the correct motor rating parameters

(F2-01~ F2-05)

**0: No operation, that is no tuning**

**1: Static tuning** It is suitable for applications where the motor and load are not easily disconnected and cannot be rotated.

**2: Rotation tuning**

**2. Vector control and VF control parametersparameters) F3 parameters**

F3-00 Vector control low speed ASR scale factor Setting Range: 0.01 ~ 30.00
F3-01 Vector control low speed ASR integral coefficient Setting Range: 0.01 ~ 10.00
F3-02 Vector control ASR switching frequency 1 Setting Range: 1.00~7.50
F3-03 Vector control high speed ASR scale factor Setting Range: 0.01 ~ 30.00
F3-04 Vector control high speed ASR integral coefficient Setting Range: 0.01 ~ 10.0
F3-05 Vector control ASR switching frequency 2 Setting Range: 8.00~50.00

The F3-00 and F3-01 parameters are the PI adjustment parameters when the operating frequency is less than the switching frequency 1 (F3-02). The F3-03 and F3-04 parameters are the PI adjustment parameters when the operating frequency is greater than the switching frequency 2 (F3-05). The PI adjustment parameter between the switching frequency 1 and the switching frequency 2 is a linear switching between the two sets of PI parameters.

The speed dynamic response characteristic of the vector control can be adjusted by setting the proportionality factor and the integration time of the speed regulator.

Increasing the proportional and integral coefficients can speed up the dynamic response of the speed loop. If the proportional coefficient and the integral coefficient are too large or the integration time is too small, the system can oscillate.



In vector control, there is a coupling relationship between torque and magnetic field. Especially at high speed, this parameter can be adjusted to reduce coupling and improve control performance.

F3-12 Voltage closed loop proportional coefficient Setting Range 0 ~100.00 F3-13 Voltage closed loop integral coefficient Setting Range 0 ~100.00
--

Vector control, high speed requires weak magnetic, otherwise the speed does not go up, the control output is the rated voltage during the field weakening process, adjusting these two parameters can improve the voltage control performance.

F3-14 Magnetic field control proportional coefficient Setting Range: 0.10~10.00 F3-15 Magnetic field control integral coefficient Setting Range: 1~500
---

F3-16 Current given filter coefficient	Setting Range 0 ~100mS
--	------------------------

F3-17 Whether torque control	Setting Range: 0, 1
F3-18 Torque given	Setting Range: 0 ~ 5
F3-19 Keyboard given torque	Setting Range: 0~200.0
F3-20 Torque given direction	Setting Range: 0, 1
F3-21 Upper limit frequency setting source selection	Setting Range: 0 ~ 5

In the vector control mode, whether F3-17 is torque control, when set to 0, the system performs speed control; when set to 1, the system performs torque control.

F3-18 Torque given:

**0: Keyboard setting torque**

**1: AI1**

**2: AI2**

**3: Multi-stage torque**



**4: RS485****5: High speed pulse**

F3-20 Torque given direction: 0: Forward 1: Reverse

F3-21 Torque control upper limit frequency setting source:

**0: Upper limit frequency set by the keyboard****1: AI1****2: AI2****3: Set the upper limit frequency in multiple segments.****4: RS485 Setting.****5: High-speed pulse**

F3-22 V/F Curve type selection	Setting Range: 0, 1, 2
--------------------------------	------------------------

**0: Constant torque curve** The output voltage of the frequency converter is proportional to the output frequency, which is the case for most loads.

**1: Decreasing torque curve**

**The output voltage of the inverter and the output frequency are in a quadratic curve relationship, which is suitable for constant power loads such as fans and pumps.**

**2. Custom curve**

The relationship between the output voltage of the inverter and the output frequency is determined by the parameters of F3-23 to F3-28.

F3-23 Custom curve F1	Setting Range: 0.00 ~ 100.0%
F3-24 Custom curve V1	Setting Range: 0.00 ~ 100.0%
F3-25 Custom curve F2	Setting Range: 0.00 ~ 100.0%
F3-26 Custom curve V2	Setting Range: 0.00 ~ 100.0%
F3-27 Custom curve F3	Setting Range: 0.00 ~ 100.0%
F3-28 Custom curve V3	Setting Range: 0.00 ~ 100.0%

The inverter automatically sorts F1, F2, F3 and V1, V2, V3 from small to large, so that the minimum frequency  $F_{min}$  corresponds to the minimum voltage  $V_{min}$ , the intermediate frequency  $F_{mid}$  corresponds to the intermediate voltage  $V_{mid}$ , and the maximum frequency  $F_{max}$  corresponds

to the maximum voltage  $V_{max}$ . . The V/F curve consists of five points: (0,0), (Fmin, Vmin), (Fmid, Vmid), (Fmax, Vmax), (rated frequency, rated voltage).

F3-29 V/F Torque boost	Setting Range: 0.0~20.0%
------------------------	--------------------------

Used to improve the low frequency torque characteristics of the frequency converter. When operating in the low frequency range, the output voltage of the inverter is boosted. This parameter has no effect when selecting a custom curve.

F3-30 Low frequency oscillation suppression strength Setting Range: 0 ~ 1000
F3-31 High frequency oscillation suppression strength Setting Range: 0 ~ 1000
F3-32 High and low frequency turning point Setting Range: 5.00 ~ 50.00Hz

When the inverter drives the motor to no load or light load, the output current of the inverter sometimes oscillates, which may sometimes too large or too small, which may cause overcurrent and overvoltage faults of the inverter. Increasing the value of F3-30 and F3-31 can increase the suppression intensity of current oscillation, but has a slight influence on the accuracy of the output frequency. Generally, the two parameters should be as small as possible under the premise of satisfying the operation. Its factory value can generally meet user requirements.

F3-33 V/F Control slip compensation coefficient	Setting Range: 0~200%
---	-----------------------

### 3. Auxiliary operating parameters (F4 parameter)

F4-00 Positive reversal dead time	Setting Range: 0.0 ~ 5.0S
-----------------------------------	---------------------------

The hold time at zero frequency output when the inverter changes the direction of operation. The positive and negative dead time is mainly set for a

large inertia load and a device that changes the mechanical dead zone when turning.

F4-01	Jump frequency1	Setting Range: 0.00Hz ~
F4-02	Jump frequency1 Amplitude	Setting Range: 0.00 ~ 5.00 Hz
F4-03	Jump frequency2	Setting Range: 0.00Hz ~Upper limit frequency
F4-04	Jump frequency2 Amplitude	Setting Range: 0.00 ~ 5.00 Hz
F4-05	Jump frequency3	Setting Range: 0.00Hz ~Upper limit frequency
F4-06	Jump frequency3 Amplitude	Setting Range: 0.00 ~ 5.00 Hz

When the load of the inverter is mechanically resonated at a certain frequency point, the resonance frequency can be avoided by the jump frequency.

There are 3 skip frequency points to choose from. If the skip frequency range is set to 0, the skip frequency is invalid.

F4-07	Jog frequency	Setting Range: 0.00 ~Upper limit frequency
F4-08	Jog acceleration time	Setting Range: 0.1 ~ 6000.0S
F4-09	Jog deceleration time	Setting Range: 0.1 ~ 6000.0S

When jog command input, the inverter will run to the jog frequency according to the set jog acceleration and deceleration time.

F4-10	acceleration time2	Setting Range: 0.1 ~ 6000.0S
F4-11	deceleration time2	Setting Range: 0.1 ~ 6000.0S
F4-12	acceleration time3	Setting Range: 0.1 ~ 6000.0S
F4-13	deceleration time3	Setting Range: 0.1 ~ 6000.0S
F4-14	acceleration time4	Setting Range: 0.1 ~ 6000.0S
F4-15	deceleration time4	Setting Range: 0.1 ~ 6000.0S
F4-16	Acceleration and deceleration	Setting Range: 0, 1

The 2nd, 3rd, and 4th acceleration and deceleration time setting values. The actual acceleration and deceleration time of the inverter running is selected by external terminal or simple PLC function parameters.

Acceleration/deceleration mode 0: Straight line Straight line acceleration

and deceleration are used for most loads; 1: S curve. The S-curve addition and deceleration are mainly provided for the load that needs to slow down noise and vibration and reduce the start-stop impact during acceleration and deceleration. as shown in picture 2.

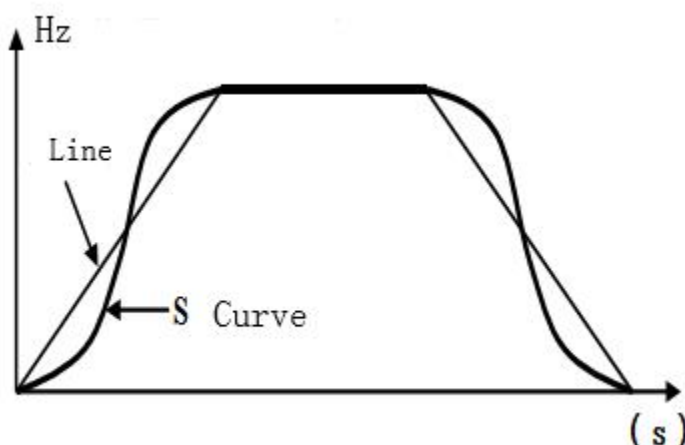

Figure 2 Acceleration and deceleration curves of the inverter

F4-17 UP/DW Terminal acceleration and deceleration rate  
Setting Range: 0.01~100.00Hz/S

F4-18 FDT1 (Frequency level) Set  
Setting Range: 0.00 ~ Upper limit frequency  
F4-19 FDT1 Detection frequency lag detection value  
Setting Range: 0.0~100.0%  
F4-20 FDT2 (Frequency level) Setting  
Setting Range: 0.00 ~Upper limit frequency  
F4-21 FDT2 Detection frequency lag detection value  
Setting Range: 0.0~100.0%

These four parameters are used to set the two frequency detection levels. When the output frequency is higher than the FDT set value F4-18 (or F4-20), the selected output terminal (Y1, Y2 terminal or relay) outputs a valid signal. When the output frequency is lower than a certain value  $F4-18 - F4-18 \times F4-19$  (or  $F4-20 - F4-20 \times F4-21$ ), the selected output terminal (Y terminal or relay) outputs an invalid signal .

F4-22 Frequency arrival detection range	Setting Range: 0.00 ~ 20.00Hz
---	-------------------------------

This parameter is a supplementary definition of the frequency arrival signal function. When the output frequency of the inverter is within the positive and negative detection range of the set frequency, the selected output terminal (Y terminal or relay) outputs a valid signal.

F4-23 PWM Modulation	Setting Range: 000 ~ 111
----------------------	--------------------------

Single digit: Whether overmodulation

0: None Modulation

1: Modulation

Decimal: Modulation way

0: Low frequency three-phase modulation, high frequency two-phase modulation

1: Three-phase modulation

Hundred: Low frequency processing

0: Carrier frequency is greater than 3Khz, low frequency carrier is limited to 3Khz

1: Carrier frequency runs as set

F4-24 Automatic voltage regulation (AVR)	Setting Range: 0, 1, 2
--	------------------------

**0: None Action**

**1: Action**

The function of the automatic voltage regulation function is to ensure that the output voltage of the inverter does not fluctuate with the fluctuation of the input voltage. When the fluctuation range of the grid voltage is large, and the motor has a relatively stable stator voltage and current, the function should be turned on.

**2: Does not act only when decelerating**

When decelerating to stop, select AVR does not work, the deceleration time is short, but the running current is relatively large; select AVR always action, the motor decelerates smoothly, the running current is relatively small, but the deceleration time will become longer.

F4-25 Droop control	Setting Range: 0.0~10.00Hz
---------------------	----------------------------

This function is applicable to the occasion where multiple inverters drive the same load. By setting this function, multiple inverters can achieve even power distribution when driving the same load. When the load of a certain inverter is heavy, the inverter will According to the parameters set by this function, the output frequency is automatically reduced appropriately to remove part of the load. This value can be gradually adjusted from small to large during debugging.

F4-26 Operation monitoring project selection1 Setting Range: 0 ~3939 F4-27 Operation monitoring project selection2 Setting Range: 0 ~ 3939 F4-28 Operation monitoring project selection3 Setting Range: 0 ~ 3939
---

The upper two bits and the lower two bits of each parameter respectively represent one d parameter, and three parameters can set a total of six d parameters. During the running of the inverter, press “Shift Key” in the monitoring state, the keyboard will display the six status parameter values set by F4-26, F4-27 and F4-28 in sequence.

F4-29 Speed display factor	Setting Range: 0.1~999.9%
----------------------------	---------------------------

When F4-29 is set to 100.0%, the output frequency of d-09 corresponds to the synchronous speed. Users can set different values according to the gear ratio to meet the user's display needs.

F4-30 Line speed display display factor	Setting Range: 0.01~99.99
---	---------------------------

Based on the displayed value of d-09, multiply by F4-30 to meet the different display needs of the user.

F4-31 Multi-function key MF.K function selection Setting Range: 0, 1, 2, 3
---

**0: Reverse**

**1: Forward turn**

**2: Reverse jog**

**3: Command channel switching**

The current command mode is the keyboard mode. This button is invalid. For other modes, press this button to switch to the keyboard mode.

#### 4. External input and output terminal definition (F5 parameter)

F5-00 AI1 Minimum input Predetermined area: 0.00~10.00V
F5-01 AI1 Minimum input corresponding setting Predetermined area: -100.0~100.0%
F5-02 AI1 Maximum input Predetermined area: 0.00~10.00V
F5-03 AI1 Maximum input corresponding setting Predetermined area: -100.0~100.0%
F5-04 AI1 filter time constant Setting range: 0.01~50.00S

By (F5-00, F5-01), (F5-02, F5-03) two points can be determined, input a straight line, get the analog input corresponding to the set frequency (when AI1 is given as PID or feedback, A percentage representing a certain actual variable can be obtained). When the set frequency is negative, the inverter output is inverted. In order to reduce the influence of the fluctuation of the

analog quantity on the control of the frequency converter, the analog quantity of the sampling is usually filtered, and is realized by setting F5-04.

F5-05 AI2 Minimum input Predetermined area: 0.00~10.00V
F5-06 AI2 AI1 Minimum input corresponding setting Predetermined area: -100.0~100.0%
F5-07 AI2 Maximum input Predetermined area: 0.00~10.00V
F5-08 AI2 Maximum input corresponding setting Predetermined area: -100.0~100.0%
F5-09 AI2 filter time constant Setting range: 0.01~50.00S

Through (F5-05, F5-06), (F5-07, F5-08) two points can be determined, input a straight line, get the analog input corresponding to the set frequency (when AI2 is given as PID or feedback, A percentage representing a certain actual variable can be obtained). When the set frequency is negative, the inverter output is inverted. In order to reduce the influence of the fluctuation of the analog quantity on the control of the inverter, the analog quantity of the sampling is usually filtered, and it is realized by setting F5-09.

AI1, AI2 support 0~20MA in hardware circuit, 0~20MA corresponds to 0~10V.

F5-10 PLUSEMinimum input Predetermined area: 0.00~50.00KHz
F5-11 PLUSEMinimum input corresponding setting Predetermined area: -100.0~100.0%
F5-12 PLUSEMaximum input Predetermined area: 0.00~50.00KHz
F5-13 PLUSEMaximum input corresponding setting Predetermined area: -100.0~100.0%
F5-14 PLUSE filter time constant Setting range: 0.01~50.00S

By (F5-10, F5-11), (F5-12, F5-13) two points can be determined, input a straight line, get the high-speed pulse input corresponding to the set frequency (when the high-speed pulse input is given as PID or feedback At that time, a percentage representing an actual variable is obtained. When the



set frequency is negative, the inverter output is inverted. In order to reduce the influence of the detected high-speed pulse frequency fluctuation on the inverter control, it is usually filtered and implemented by setting F5-14.

F5-15 External operation command control method  
Predetermined area: 0, 1, 2, 3

**This parameter is used to set the external terminal command control mode:**

FWD selects the forward rotation function for the external terminal, and this terminal is called FWD.

REV selects the reverse function for the external terminal, which is referred to as REV.

#### 0: Two-wire control mode 1

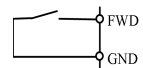
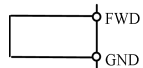
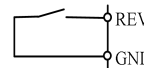
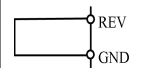
Instruction	Downtime	Run	Forward instruction	Reverse instruction
Terminal status				

#### 1: Two-wire control mode 2

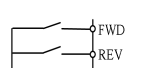
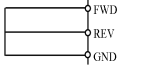
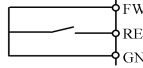
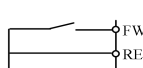
Instruction	Stop instruction		Forward instruction	Reverse instruction
Terminal status				

#### 2: Three-wire control mode 1

A three-wire control terminal must be selected (see parameters F5-16 to F5-21 for instructions). The wiring diagram of the three-wire control mode is shown in Figure 3. X? For the three-wire operation control terminal, one of the input terminals X1 to X6 is selected by parameters F5-16 to F5-21. SW1 is the inverter stop trigger switch, SW2 is the forward rotation trigger switch, and SW3 is the reverse rotation trigger switch.



a) Three-wire control mode 1 wiring diagram

b) Three-wire control mode 2 wiring diagram

Image 3 Three-wire control mode wiring diagram

### 3:Three-wire control mode 2

X? is the three-wire operation control terminal, one of the input terminals X1 to X6 is selected by parameters F5-16 to F5-21. SW1 is the inverter stop trigger switch, SW2 is the forward dictate trigger switch, and K is the reverse switch.

If X1 is selected, the wiring is as shown in Figure 4:

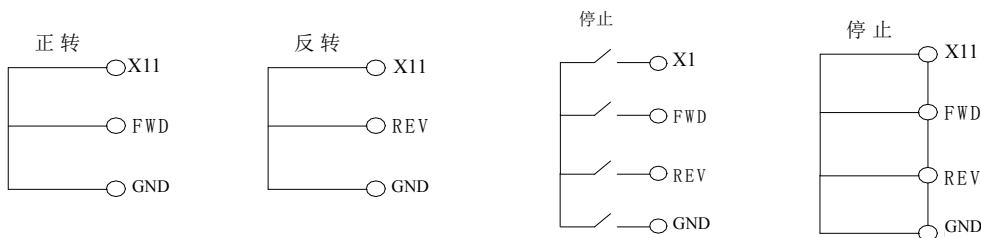

Figure 4 Description of the three-wire control command

F5-16 X1 Function selection	Predetermined area: 0~40
F5-17 X2 Function selection	Predetermined area: 0~40
F5-18 X3 Function selection	Predetermined area: 0~40
F5-19 X4 Function selection	Predetermined area: 0~40
F5-20 X5 Function selection	Predetermined area: 0~40

0: No functions

1: FWD Forward dictate

2: REV Reverse

3: External fault input (normally open)

4: DC brake at stop

- 5: Emergency stop input
- 6: Fault reset input
- 7: Multi-speed input 1
- 8: Multi-speed input 2
- 9: Multi-speed input 3
- 10: Multi-speed input 4
- 11: Three-wire control
- 12: Terminal UP
- 13: Terminal DOWN
- 14: Terminal clear
- 15: Acceleration/deceleration selector 1
- 16: Acceleration/deceleration selector 2
- 17: PLC Pause (stop at current frequency) in operation
- 18: PLC State reset (method 1, 2)
- 19: Forward jog
- 20: Reverse jog
- 21: Swing frequency pause (stop at current frequency) in operation
- 22: Swing frequency reset(reset to center frequency) in operation
- 23: PID Pause (stop at current frequency) in operation
- 24: Internal timer allows
- 25: Internal timer clear
- 26: Counter trigger input
- 27: Counter reset (reset to 0)
- 28: Frequency given A and B switching
- 29: Frequency given A and A+B switching
- 30: Frequency given B and A+B switching

When the frequency is given as A, the function of No. 28 can be used to switch A to function B and No.29 switch to A+B. When the frequency is given as B, it can be switched to A+B through the function of No. 30.

## 31: Acceleration and deceleration stop

The running frequency of the inverter is not affected by the external frequency given signal, except for the stop command.

## 32: Torque control prohibited

When torque control is selected, this function is active and switches to speed control.

## 33: Length counter input

## 34: Length counter clear

## 35: Command given source forced to LED keyboard

## 36: Command given source forced to terminal

## 37: Command given source forced to communication control

If the functions of 35 to 37 are valid, the large function is preferred, and the function of the 35 is valid.

38: PID control parameter selection, when Fb-09=1, when there is a terminal to select this function, and the terminal is valid, the PID proportional, integral, and differential parameters select the second group; otherwise, the first group is selected.

## 39: External fault normally closed input

The internal sampling of the faultless main control board is valid, and the fault is invalid.

## 40: Pulse input (high speed, only valid for X6)

F5-27	Y	Output setting	Predetermind area: 0 ~ 20
F5-28	TA -TB -TC1	Output setting	Predetermind area: 0 ~20
F5-29	TA -TB -TC2	Output setting	Predetermind are: 0 ~20

## 0: No function

## 1: Running status

## 2: Fault output

## 3: Frequency arrival

## 4: Detection frequency FDT1 arrives

- 5: Detection frequency FDT2 arrives
- 6: Zero speed operation
- 7: Lower limit frequency arrival
- 8: Upper limit frequency arrival
- 9: The specified value of the counter arrives (greater than the specified value, the output is ON)
- 10: The final value of the counter arrives (equal to the final value and outputs an ON signal for one count clock cycle)
- 11: Internal timer arrives (outputs a timing unit ON signal)
- 12: Running time reached (greater than set time outputs ON)
- 13: PLC phase operation completed (output 0.5S ON signal)
- 14: PLC running cycle is completed (output 0.5S ON signal)
- 15: Over torque warning
- 16: Inverter standby
- 17: Length reached
- 18: Sleeping
- 19: AI1 Overrun
- 20: Module temperature reached

F5-34 Analog output AO1 stands for variable setting

Predetermined area: 0 ~ 20

F5-35 AO1 Corresponding variable 0% Corresponding analog output

Predetermined area: 0 ~ 100.0%

F5-36 AO1 Corresponding variable 100% Corresponding analog output

Predetermined area: 0 ~ 100.0%

Analog AO1 represents variable selection:

- 0: Set frequency (100% corresponds to the upper limit frequency)
- 1: Running frequency (100% corresponds to the upper limit frequency)
- 2: Output current (100% corresponds to 200% of rated current)
- 3: Bus voltage (100% corresponds to 150% of rated bus voltage)
- 4: Output voltage (100% corresponds to 100% of rated voltage)
- 5: Output power (100% corresponds to 200% of rated power)

- 6: Torque current (100% corresponds to 200% of rated current)
- 7: AI1
- 8: AI2
- 9: Extended AI3
- 10: High speed pulse input
- 11: RS485 setting
- 12: Length (100% corresponds to the length set by F9.06)
- 13: Count value (100% corresponds to the final count value set by F9.05)
- 14 ~ 20 Reserved

User terminal AO1, select 0~10V jumper, F5-35, F5-36 100.0%, corresponding to 10.00V, select 0~20mA jumper, F5-35, F5-36 100.0%, corresponding to 20mA.

F5-39 AO2 Output mode selection      Predetermined area: 0 , 1  
 F5-40 High speed pulse output upper limit Predetermined area: 0.10 ~ 50.00KHz  
 F5-41 AO2 Representative variable setting      Predetermined area: 0 ~ 20  
 F5-42 AO2 corresponding variable 0% corresponds to analog output  
 Predetermined area: 0 ~ 100.0%  
 F5-43 AO2 corresponding variable 100% corresponds to analog output AO2  
 Predetermined area: 0 ~ 100.0%

AO2 output mode selection:

- 0: Analog output, 100.0% in F5-42 and F5-43, corresponding to 10.00V.
- 1: High-speed pulse output, the maximum frequency of output is determined by F5-40, 100.0% of F5-42 and F5-43, corresponding to F5-40.

## 5. PID Parameter (F6 parameter)

F6-00 PIDSet channel selection      Predetermined area: 0~7

This parameter is used to select the input channel of the PID instruction:

- 0: Keyboard potentiometer given
- 1: Reserved
- 2: F6.01 Given



before the PID is started, and then transfer to the PID control. This pre-set frequency is determined by F6-08 and the duration is determined by F6-09.

F6-10 PID Feedback disconnection detection threshold

Predetermined area: 0.0 ~ 20%

F6-11 PIDWire break detection delay time

Predetermined area: 0.0 ~ 100.0S

When F6-10 is set to 0, the PID feedback disconnection detection does not work. When the setting is greater than 0, when the feedback signal is less than F6-10 and continues to exceed F6-11, the system reports that the PID disconnection is faulty.

F6-10 PIDNegative output limit Predetermined area: 0.0 ~100.0%

F6-11Maximum output deviation twice Predetermined area:0.00 ~ 100.00%

The maximum value of the PID output is 100%, which corresponds to the upper limit frequency. In some occasions, it is hoped that the PID output can control the motor to reverse direction and set F6-10 to a non-zero value. The inverter can automatically adjust the forward and reverse speed according to the given and feedback signal deviation.

In order to reduce the impact of rapid changes in PID output on the load system, the F6-11 can be adjusted to achieve perfect uniformity of speed and stability.

## 6. Multi-speed and PLC parameters (F7 parameters)

F7-00PLC Operation mode and parameter selectio Predetermined area :  
0~1112

This parameter determines the PLC operation mode, which is realized by configuring different units, tens, hundreds, and thousands.

Units:

0: Single run end shutdown



1: Keep the final value after a single run

2: Unlimited loops

After a running cycle, restart from the first speed running with the running time not 0, in order.

Tens:

0: Running time in seconds

1: Running time in minutes

Hundreds : reserved

Thousands: restart mode selection

0: Every start starts from the 0th paragraph

F7-01 Multi-speed frequency 0	Predetermined area: 0.00~100.0%
F7-02 Multi-speed frequency 1	Predetermined area :0.00~100.0%
F7-03 Multi-speed frequency 2	Predetermined area:0.00~100.0%
F7-04 Multi-speed frequency 3	Predetermined area:0.00~100.0%
F7-05 Multi-speed frequency 4	Predetermined area:0.00~100.0%
F7-06 Multi-speed frequency 5	Predetermined area:0.00~100.0%
F7-07 Multi-speed frequency 6	Predetermined area:0.00~100.0%
F7-08 Multi-speed frequency 7	Predetermined area:0.00~100.0%
F7-09 Multi-speed frequency 8	Predetermined area:0.00~100.0%
F7-10 Multi-speed frequency 9	Predetermined area:0.00~100.0%
F7-11 Multi-speed frequency 10	Predetermined area:0.00~100.0%
F7-12 Multi-speed frequency 11	Predetermined area:0.00~100.0%
F7-13 Multi-speed frequency 12	Predetermined area:0.00~100.0%
F7-14 Multi-speed frequency 13	Predetermined area:0.00~100.0%
F7-15 Multi-speed frequency 14	Predetermined area:0.00~100.0%
F7-16 Multi-speed frequency 15	Predetermined area:0.00~100.0%

1: Start every run from the interrupt frequency

These parameters are used to set the output frequency when the terminal controls multi-speed operation or programmable multi-speed (simple PLC) operation. The following table shows the multi-speed frequency corresponding to the multi-speed terminal combination. Among them, the corresponding 1 of the multi-speed control terminal is valid, and the corresponding 0 means invalid.

Control terminal 1	Control terminal 2	Control terminal 3	Control terminal 4	Corresponding to multi-speed	Control terminal 1	Control terminal 2	Control terminal 3	Control terminal 4	Corresponding to multi-speed
0	0	0	0	0	0	0	0	1	8
1	0	0	0	1	1	0	0	1	9
0	1	0	0	2	0	1	0	1	10
1	1	0	0	3	1	1	0	1	11
0	0	1	0	4	0	0	1	1	12
1	0	1	0	5	1	0	1	1	13
0	1	1	0	6	0	1	1	1	14
1	1	1	0	7	1	1	1	1	15

The multi-speed control terminal is selected by parameters F5-16~F5-21.

The PLC running time, running direction and running time are set by parameters F7-17~F7-48.

F7-17 Phase 0 running time	Predetermined area: 0.0 ~ 3000.0
F7-18 Stage 0 running direction and acceleration/deceleration	
Predetermined area: 0~31	
F7-19 Phase 1 running time	Predetermined area : 0.0 ~ 3000.0
F7-10 Stage 1 running direction and acceleration/deceleration	
Predetermined area: 0~31	
F7-21 Phase 2 running time	Predetermined area : 0.0 ~ 3000.0
F7-22 Stage 2 running direction and acceleration/deceleration	
Predetermined area: 0~31	
F7-23 Phase 3 running time	Predetermined area : 0.0 ~ 3000.0
F7-24 Stage 3 running direction and acceleration/deceleration	
Predetermined area: 0~31	
F7-25 Phase 4 running time	Predetermined area : 0.0 ~ 3000.0
F7-26 Stage 4 running direction and acceleration/deceleration	
Predetermined area: 0~31	
F7-27 Phase 5 running time	Predetermined area : 0.0 ~ 3000.0
F7-28 Stage 5 running direction and acceleration/deceleration	
Predetermined area: 0~31	
F7-29 Phase 6 running time	Predetermined area : 0.0 ~ 3000.0
F7-30 Stage 6 running direction and acceleration/deceleration	
Predetermined area: 0~31	
F7-31 Phase 7 running time	Predetermined area : 0.0 ~ 3000.0
F7-32 Stage 7 running direction and acceleration/deceleration	
Predetermined area: 0~31	
F7-33 Phase 8 running time	Predetermined area : 0.0 ~ 3000.0
F7-34 Stage 8 running direction and acceleration/deceleration	
Predetermined area: 0~31	
F7-35 Phase 9 running time	Predetermined area : 0.0 ~ 3000.0
F7-36 Stage 9 running direction and acceleration/deceleration	
Predetermined area: 0~31	
F7-37 Phase 10 running time	Predetermined area : 0.0 ~ 3000.0
F7-38 Stage 10 running direction and acceleration/deceleration	
Predetermined area: 0~31	
F7-39 Phase 11 running time	Predetermined area : 0.0 ~ 3000.0
F7-40 Stage 11 running direction and acceleration/deceleration	
Predetermined area: 0~31	
F7-41 Phase 12 running time	Predetermined area : 0.0 ~ 3000.0
F7-42 Stage 12 running direction and acceleration/deceleration	
Predetermined area: 0~31	
F7-43 Phase 13 running time	Predetermined area : 0.0 ~ 3000.0
F7-44 Stage 13 running direction and acceleration/deceleration	
Predetermined area: 0~31	

F7-41 Phase 12 running time	Predetermined area : 0.0 ~ 3000.0
F7-42 Stage 12 running direction and acceleration/deceleration	
Predetermined area: 0~31	
F7-43 Phase 13 running time	Predetermined area : 0.0 ~ 3000.0
F7-44 Stage 13 running direction and acceleration/deceleration	
Predetermined area: 0~31	
F7-45 Phase 14 running time	Predetermined area : 0.0 ~ 3000.0
F7-46 Stage 14 running direction and acceleration/deceleration	
Predetermined area: 0~31	
F7-47 Phase 15 running time	Predetermined area : 0.0 ~ 3000.0
F7-48 Stage 15 running direction and acceleration/deceleration	
Predetermined area: 0~31	

The running direction and acceleration/deceleration time of each stage are determined by setting different units and ten digits:

Units:

0: forward

1: reverse

Ten places:

0: Acceleration/deceleration time 1

1: acceleration and deceleration time 2

2: Acceleration and deceleration time 3

3: Acceleration and deceleration time 4

## 7. Communication parameters (F8 parameters)

F8-00 Baud rate	Predetermined area: 0 ~ 7
-----------------	---------------------------

Used to specify the baud rate for RS485 communication, the communication parties must set the same baud rate.

**0: 300 bps**

**1: 600 bps**

**2: 1200 bps**

**3: 2400 bps**

**4: 4800 bps**

**5: 9600 bps**

**6: 19200 bps**

**7: 38400 bps**

F8-01 Data Format

Predetermined area: 0 , 1, 2

Used to specify the data format for RS485 communication, the communication parties must use the same data format.

**0: 1 start bit, 8 data bits, 1 stop bit, no parity.**

**1:1 start bit, 8 data bits, 1 stop bit, odd parity.**

**2: 1 start bit, 8 data bits, 1 stop bit, even parity.**

F8-02 Local address

Predetermined area: 0 ~247

This parameter is used to set the address of the inverter when RS485 communication. The inverter only receives the data of the host computer that matches the site of the station. The communication protocol uses the standard MODBUS RTU protocol, as detailed in Appendix 1. When this parameter is set to 0, no data is returned for the broadcast address.

F8-03 Local response delay

Predetermined area: 0 ~ 100ms

The response delay refers to the delay between the inverter receiving the 485 command and the response to the return of the host computer.

F8-04 Timeout judgment time

Predetermined area: 0.1 ~ 100.0S

When the 485 communication is unsuccessful, its duration exceeds the set time of this parameter, and the inverter determines the communication failure. When this parameter is set to 0.0, the timeout judgment function is invalid.

F8-05 Master and slave selection

Predetermined area: 0 , 1

0: slave 1: master station

In the main station, the real-time broadcast transmits the running frequency and running status of the unit so that the slave can follow.

F8-06 RS485 Set frequency proportional coefficient Predetermined area:  
0~999.9%

RS485 receives the signal from the host computer and multiplies it by F8-06 as the actual given frequency.

## 8. Advanced parameters (F9 parameters)

F9-00 Swing frequency amplitude	Predetermined area: 0.0~50.0%
F9-01 Kick frequenc	Predetermined area: 0.0~50.0%
F9-02 Triangle wave rise time	Predetermined area: 0.1 ~ 3600.0S
F9-03 Triangle wave fall time	Predetermined area: 0.1 ~3600.0S
F9-04 Counter specified value	Predetermined area: 0 ~ 65535
F9-05 Counter final value	Predetermined area: 0 ~ 65535

The inverter receives the external pulse through the multi-function input terminal and counts it. When the count value reaches the value specified by the F9-04 counter, if the multi-function output terminal Y or the relay output function selects the function of the 9th (the counter specified value arrives), it will output Active level until the counter is cleared.

When the count value reaches the final value of the F9-05 counter, if the multi-function output terminal Y or the relay output function selects the function No. 10 (the counter final value arrives), a count cycle active level is output.

F9-06 Set length	Predetermined area: 0 ~ 65535m
F9-07 Pulse number per meter	Predetermined area: 0.1 ~ 6553.5

The two functions of setting the length and the number of pulses per meter are mainly used for fixed length control. The actual length is calculated by the pulse signal input from the digital input terminal:

$$\text{Actual length} = \text{length count input pulse} / \text{number of pulses per meter.}$$

F9-08 Internal timer timing unit	Predetermined area: 0.01~99.99S
F9-09 Internal timer period	Predetermined area: 1 ~ 65535

The internal timer is enabled through the multi-function input terminal. When the timer is timed to F9-08×F9-09, and the multi-function output terminal Y or the relay output function selects the 11th function (internal timer

arrives), a timing is output. The effective signal of the unit.

F9-10 Set run time	Predetermined area: 1 ~ 65535
--------------------	-------------------------------

When the running time is greater than F9-10, and the multi-function output terminal Y or the relay output function selects the 12th function (running time arrives), a valid signal is output.

## 9. Enhanced control parameters (FA parameters)

FA-00 Whether VF separation	Predetermined area: 0~2
FA-01 Voltage source selection	Predetermined area: 0~5
FA-02 Keyboard setting voltage given	
Predetermined area: 0.0~100.0%	
FA-03 Voltage acceleration/deceleration time	
Predetermined area: 0.1~3600.0S	

**When VF control is selected, FA-00 is the voltage separation parameter:**

0: No separation, ie normal VF control

1: Semi-separated, the output voltage of the inverter has a linear relationship with the frequency, and the ratio of the two is controlled by the voltage source selected by FA-01.

2: Completely separated, the output voltage of the inverter has no relationship with the frequency, and is only controlled by the voltage source selected by FA-01.

**FA-01 voltage source selection:**

0: FA-02 Set value      1: AI1      2: AI2

3: Keyboard potentiometer      4: PID      5: AI1+PID

**FA-02 is the set voltage given** 100.0% corresponds to the rated voltage of the motor

**FA-03 voltage acceleration and deceleration time** Refers to the time from zero to the rated voltage.

## 10. Enhanced function parameters (FB parameters)

Fb-00 Remote pressure gauge range  
Predetermined area: 0.001~60.000MPA

Fb-01 Keyboard pressure setting  
Predetermined area: 0.001~20.000MPA

Fb-02 Modify whether the keyboard settings are automatically saved  
Predetermined area: 0~1

Fb-03 Sleep frequency  
Predetermined area: 0.00~600.00Hz

Fb-04 Sleep delay time  
Predetermined area: 0.0~3000.0S

Fb-05 Wake up pressure  
Predetermined area: 0~100.0%

Fb-06 Wake delay time  
Predetermined area: 0.0~60.0S

Fb-07 Underload protection value  
Predetermined area: 0.0~100.0%

Fb-08 allowed underload time  
Predetermined area: 5.0~600.0S

Fb-00 remote pressure gauge range refers to the actual pressure gauge range, and the pressure gauge outputs 10V or 20mA corresponding pressure value.

Fb-01 keyboard pressure setting, select PID given frequency and PID selection. When selecting Fb-01, in the monitoring state, Fb-01 can be modified by keyboard up and down buttons regardless of running or stopping.

Fb-02 determines whether the modified set value is automatically stored, 0: no automatic storage, need to press SET to store; 1: automatic storage, automatically stored after 10S modification. This parameter also affects whether F0-07 and F6-01 parameters are automatically stored.

When the PID output frequency is lower than the Fb-03 setting and the duration exceeds Fb-04, the inverter enters the sleep state (output frequency is 0). When the feedback pressure is less than a certain value (Fb-05 multiplied by the set pressure), And when the duration exceeds Fb-06, the inverter will go out of sleep and work again.

When Fb-07 is 0.0, no underload protection is performed. When Fb-07



is non-zero, when the inverter output current (percentage of rated current) is less than Fb-07 setting and the duration exceeds Fb-08, E. UL fault is reported.

Fb-09 PID Parameter selection	Predetermined area: 0~3
Fb-10 Proportional gain 2	Predetermined area: 0.0~50.0
Fb-11 Integral time constant 2	Predetermined area: 0.1~100.0
Fb-12 Differential gain 2	Predetermined area: 0.0~5.0
Fb-13 PIDParameter switching deviation1	
Predetermined area: 0.0~100.0%	
Fb-14 PIDParameter switching deviation2	
Predetermined area: 0.0~100.0%	
Fb-15 PIDParameter switching deviation 1	
Predetermined area: 0.0~100.0%	
Fb-16 PIDParameter switching deviation2	
Predetermined area: 0.0~100.0%	

#### **Fb-09 PID parameter selection:**

0: PID proportional coefficient, integral time constant, differential gain select the first group (F6-04, F6-05, F6-06).

1: PID proportional coefficient, integral time constant, differential gain  
According to the terminal selection (function No. 38), when the function is invalid, the first group (F6-04, F6-05, F6-06) is selected. When the function is valid, select the second group (Fb-10, Fb-11, Fb-12).

2: The actual PID scale factor, integral time constant, differential gain, adjusted according to the deviation size, when the deviation is less than Fb-13, then run according to the first group (F6-04, F6-05, F6-06); greater than Fb-14 , according to the second group (Fb-10, Fb-11, Fb-12); the deviation is greater than Fb-13, less than Fb-14, the actual parameters are obtained by linear interpolation.

3: The actual PID scale factor, integral time constant, differential gain, according to the output frequency size adjustment, when the output frequency is less than Fb-15, then run according to the first group (F6-04,

F6-05, F6-06); greater than Fb -16, then run according to the second group (Fb-10, Fb-11, Fb-12); if the output frequency is greater than Fb-15 and less than Fb-16, the actual parameters are obtained by linear interpolation.

### 11. Protection parameter (Fd parameter)

Fd-00 Current limit value	Predetermined area: 100.0~200.0%
Fd-01 Current too large frequency down time	Predetermined area: 1.0~200.0S

In order to suppress frequent occurrence of overcurrent faults, when the inverter current is too large, the inverter quickly reduces frequency to suppress excessive current.

Fd-02 Voltage limit value	Predetermined area: 100.0~140.0%
Fd-03 Voltage suppression gain	Predetermined area: 0~10

During the deceleration process, the inverter's kinetic energy feedback on the busbar causes the busbar voltage height. In order to suppress the overvoltage fault, the inverter automatically lengthens the deceleration time when the bus voltage rises to a certain value.

Fd-02 is the percentage of the rated DC bus (for a 220V rated bus voltage of 311V, the 380V system rated bus voltage is 537V).

The larger the Fd-03 setting, the stronger the overvoltage suppression capability.

Fd-04 Phase loss protection function selection	Predetermined area: 00 ~ 11
--	-----------------------------

Units: input phase loss, low power no input phase loss protection

0: no protection

1: protection

Ten digits: output phase loss

0: no protection

1: protection

Fd-05 Motor overload protection factor	Predetermined area: 50 ~ 100%
--	-------------------------------

This parameter is used to set the sensitivity of the inverter to the thermal relay protection of the load motor. When the rated current value of the load motor does not match the rated current of the inverter, the correct thermal protection of the motor can be achieved by setting this value. The smaller the setting value, the easier it is to report motor overload protection.

Fd-06 Over torque warning value	Predetermined area: 20.0~200.0%
Fd-07 Over torque detection time	Predetermined area: 0.0~60.0S

When the inverter current is greater than Fd-06 and the duration exceeds Fd-07, if the multi-function output terminal Y1 or the relay output function selects the 15th function (over-torque warning), the active level will be output.

Fd-08 Failure self-recovery	Predetermined area: 0~5
Fd-09 Failure self-recovery interval	Predetermined area: 0.1 ~ 600.0S

During the operation of the inverter, due to load fluctuations, accidents may occur and the output will be stopped. In this case, in order to stop the operation of the equipment, the fault self-recovery function of the inverter can be used. If the inverter fails to resume operation within the set number of times, the fault is protected and the output is stopped. When the number of failure self-recovery is set to zero, the self-recovery function is turned off.

The self-recovery function is not effective for fault protection caused by overload, overheating, etc.

Fd-14 First two fault numbers	Predetermined area: 0~30	Fd-15
Previous trouble number	Predetermined area: 0~30	
Fd-16 Current fault number	Predetermined area: 0~30	
Fd-17 Current fault frequency	Setting range: 0~ upper limit frequency	
Fd-18 Current fault current	Predetermined area: 0~3000.A	
Fd-19 Current fault bus voltage	Predetermined area: 0~800	

The fault number is:

- 01: E.SC short circuit
- 02: Hardware overcurrent in E.OC1 acceleration
- 03: Hardware overcurrent in E.OC2 deceleration
- 04: E.OC3 hardware overcurrent in constant speed
- 05: E.OC4 software overcurrent
- 06: E.232. Two CPU downlink communication error
- 07: E.Gnd output ground protection
- 08: E.OU1 overpressure during acceleration
- 09: E.OU2 overvoltage during deceleration
- 10: E.OU3 over-speed in constant speed
- 12: Reserved
- 13: Reserved
- 14: E.UL underload protection
- 15: E.OL1 inverter overload
- 16: E.OL2 motor overload
- 17: E.Cur current detection circuit failure
- 18: E. LU undervoltage, low voltage during operation
- 19: E.EF1 external fault (terminal input normally open)
- 20: E.EF2 external fault (terminal input normally closed)
- 21: E. OH temperature is too high
- 22: E.SPI input phase loss
- 23: E.SPO output phase loss.
- 24: E.EEP memory error

- 25: E.End running time to
- 26: E.P1d PID feedback disconnection
- 27: E.485 485 disconnection
- 28: E.doG electromagnetic interference
- 29: E.232 Two CPU communication errors

## Appendix 3 Maintenance

Due to the influence of ambient temperature, humidity, dust, vibration and aging of the internal components of the inverter, some potential problems may occur during the operation of the inverter. In order to enable the inverter to operate for a long time and stably, it is necessary to carry out the inverter. Daily and regular maintenance.

### 1. Daily inspection and maintenance

Check item	Check content	Criterion
Operating environment	1. Temperature, humidity	1. Turn on the inverter cover when the temperature > 40 °C Humidity < 90%, no frost
	2. Dust, gas	2. No odor, no flammable, explosive gas
Cooling system	1. Installation environment	1. The installation environment is well ventilated and the air duct is non-blocking.
	2. Inverter body fan	2. The main body fan runs normally without abnormal noise
Frequency converter body	1. Vibration, temperature rise	1. Smooth vibration, normal air outlet temperature
	2. Noise	2. No abnormal noise, no smell
	3. Wires, terminals	3. The fastening screw is not loos
Motor	1. Vibration, temperature rise	1. Smooth operation and normal temperature
	2. Noise	2. No abnormalities, uneven noise
Input and output parameters	1. Input voltage	1. The input voltage is within the specified range
	2. Output current	2. The output current is below the rated value

## 2. Regular maintenance

Users are advised to perform a regular inspection of the inverter every 3 months or every 6 months depending on the usage.

### 2.1 Check content

1. Whether the control circuit terminal block screws are loose, if loose, please use a screwdriver to tighten.
2. If the main circuit terminal block screws are loose, if it is loose, please reinforce. Whether there is any trace of overheating at the copper bar joint.
3. Main circuit cable, control circuit cable for damage, especially the skin that is in contact with the metal surface is cut. Is the insulation of the main circuit power cable good?
4. Thoroughly clean the air duct, body fan, and dust on the circuit board; in a dusty environment, clean it frequently.

## 3. Inspection and replacement of consumable parts

The internal consumable parts of the inverter mainly include a cooling fan and an electrolytic capacitor for filtering. Its service life is closely related to the use environment and maintenance conditions. The general life expectancy is:

Device name	Lifetime
cooling fan	30,000to 40,000 hours
Electrolytic capacitor	40,000to 50,000 hours

The user can determine the replacement period based on the running time.

### 3.1 cooling fan

Possible causes of damage: cracks in the bearing wear, blade aging, etc.

Judgment standard: The sound is abnormal when starting up. Please check the fan carefully. When it is determined that the fan is faulty, replace the fan in time.

### 3.2 Filter capacitor

Possible causes of damage: high ambient temperature; frequent load changes cause excessive pulsating current; electrolyte aging.

Judging criteria: whether there is liquid leakage; whether the safety valve protrudes; the measurement of electrostatic capacitance; the determination of insulation resistance

## **4. Storage and warranty**

### **4.1 Storage**

If the inverter is not used or stored for a long time after purchase, the following items should be noted:

(1) Avoid storing the inverter in a place with high temperature, humidity or vibration or metal dust to ensure good ventilation.

(2) If the inverter is not used for a long time, it should be powered once every two years to restore the characteristics of the filter capacitor and check the function of the inverter. When power is on, the voltage should be gradually increased by an autotransformer, and the power-on time is not less than 5 hours.

### **4.2 Warranty**

The warranty period of this inverter is 18 months (from the date of purchase). Domestic market: Due to the quality of the product itself, it will be repaired within 18 months from the date of shipment; foreign market: repair within 6 months. The warranty covers only the drive body. Even if the warranty period is exceeded, the company also provides lifetime paid repair services. See warranty agreement and warranty card.



## Appendix 4 Inverter size

1. Single-phase inverter and three-phase mini inverter size (dimensions in mm)

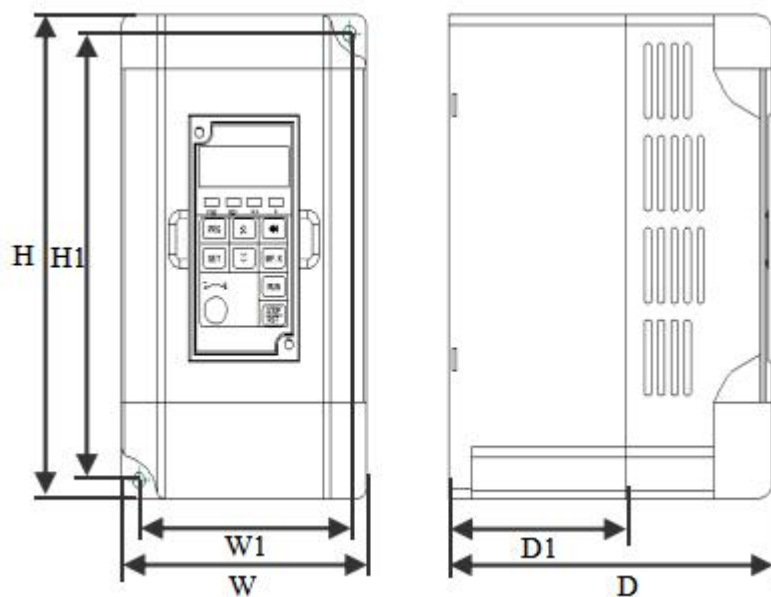

power	H	H1	W	W1	D	D1	Mounting aperture
0.75~1.5K W	143	132	86	74	114	62.5	4.5

## 2. Three-phase inverter (dimension unit is mm)

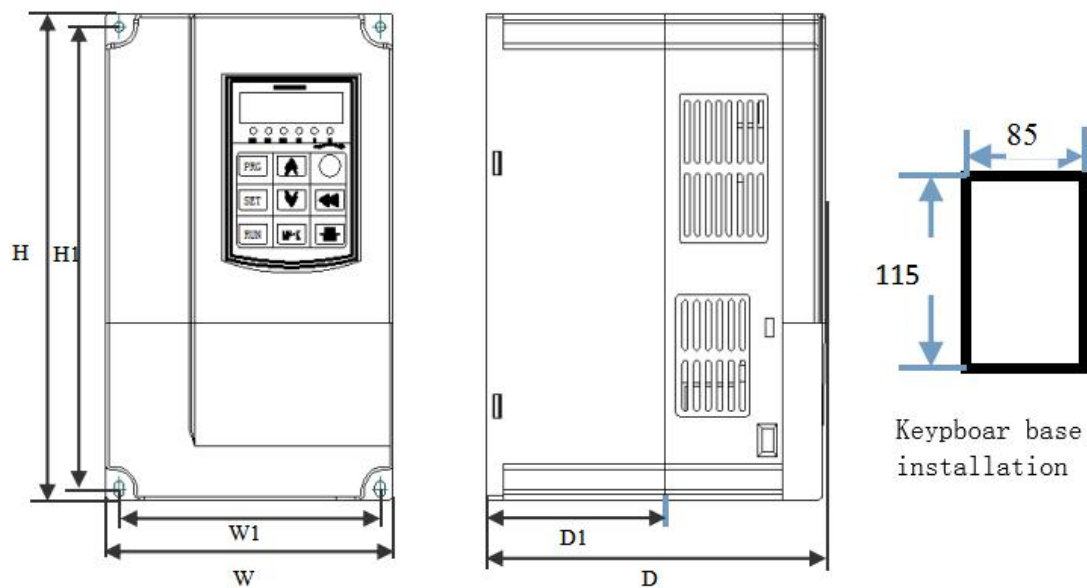

power	H	H1	W	W1	D	D1	Mounting aperture
0.75~2.2K W	185	175	118	105	157	80	4.5
4~11KW	247	235	160	147	178	101	5